



MINECRAFT

21244





Get excited about our new packaging!

We're switching from plastic to paper-based packaging. That's why you might find a mix of paper and plastic in our boxes!

Nos nouveaux emballages vous emballeront !

Nous passons des emballages en plastique aux emballages à base de papier. C'est pourquoi vous pourriez trouver un mélange de papier et de plastique dans nos boîtes !

¡Te presentamos nuestros nuevos empaques!

Estamos sustituyendo las bolsas de plástico por bolsas con base de papel. ¡Por eso, puedes encontrar una mezcla de papel y de plástico en nuestras cajas!

[LEGO.com/sustainable-packaging](https://www.lego.com/sustainable-packaging)



BUILDER



Apple and the Apple logo are trademarks of Apple Inc., registered in the U.S. and other countries and regions. App Store is a service mark of Apple Inc. Google Play and the Google Play logo are trademarks of Google LLC. Tencent and the Tencent logo are trademarks of Tencent Inc.

Q [LEGO.com/devicecheck](https://www.lego.com/devicecheck)

EN Ask parents' permission before going online | **DE** Eltern um Erlaubnis bitten, bevor du online gehst | **FR** Demande l'autorisation d'un parent avant d'aller en ligne | **IT** Chiedi il permesso ai tuoi genitori prima di andare online | **ES** Pídeles permiso a tus papás antes de conectarte a Internet | **PT** Peça autorização aos pais antes de acederes online | **JA** オンラインになる前に ほかの方のきよかもをもらおう | **ZH** 上网前应先征得父母的同意 | **KO** 온라인 접속 전에 보호자 동의가 필요합니다 | **RU** Спроси разрешения у родителей, прежде чем заходить в интернет | **PL** Poproś rodziców o zgodę, zanim wejdiesz do Internetu | **CS** Než půjdeš na internet, požádej rodiče o svolení | **SK** Skôr než pôjdeš na internet, vypýtaj si povolenie od rodičov | **HU** Kérj szülői engedélyt, mielőtt online csatlakoznál! | **RO** Cere permisiunea părinților înainte de a te conecta online | **BG** Поискайте разрешение от родител, преди да влезете онлайн | **LV** Pirms došanās tiešsaistē palūdz atļauju vecākiem | **ET** Enne Interneti kasutamist küsi vanematelt luba | **LT** Prieš prisijungdami prie interneto, atsilkauskite tėvų

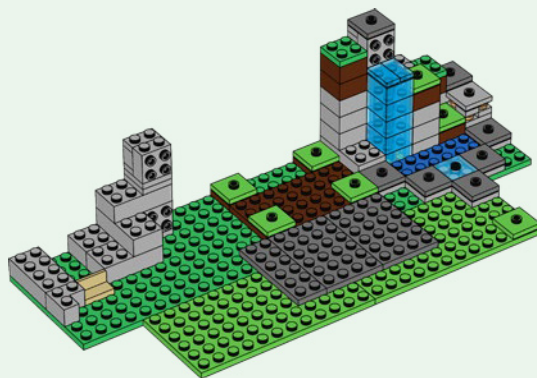

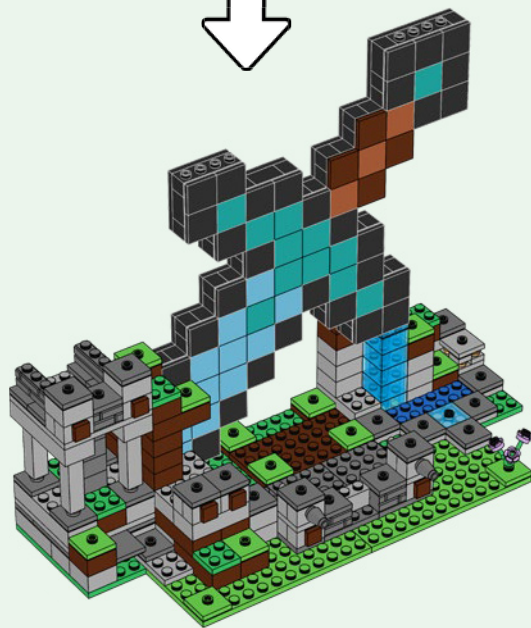
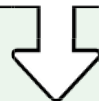
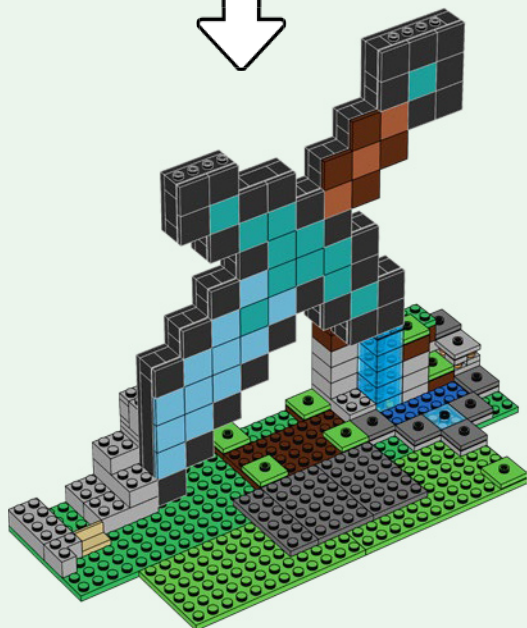
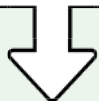

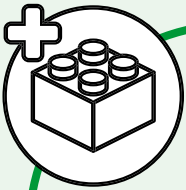

1x

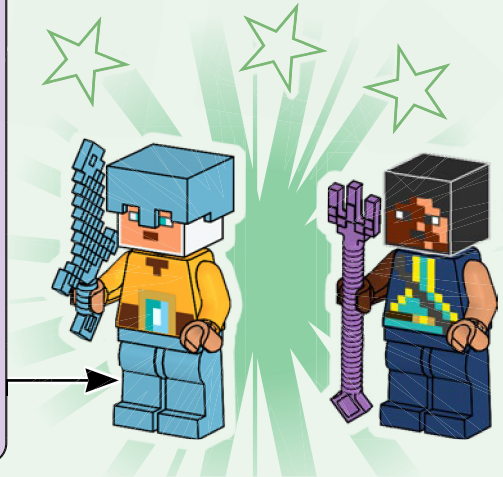
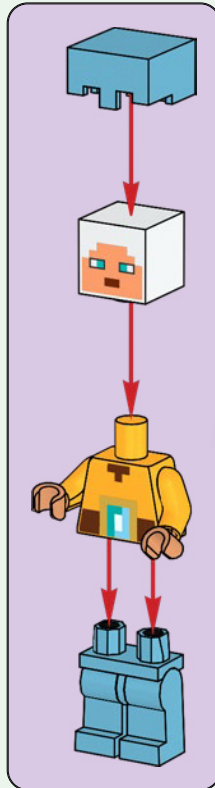

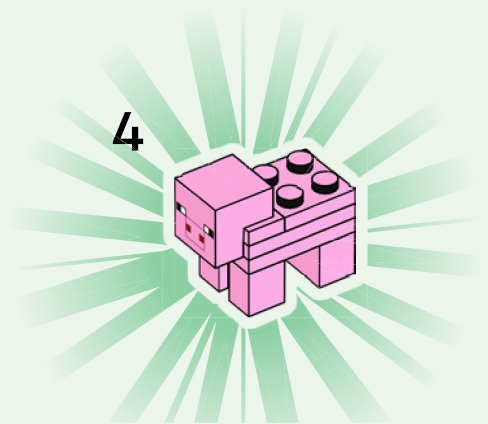
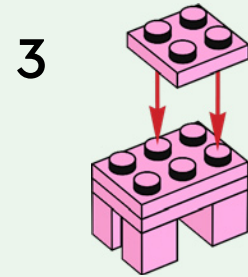
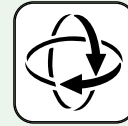
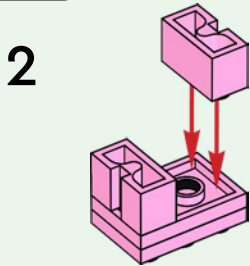
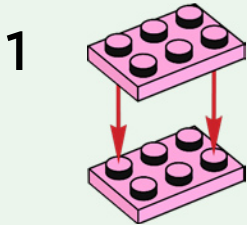
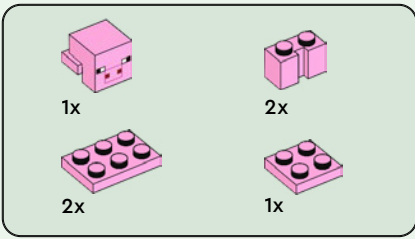

1

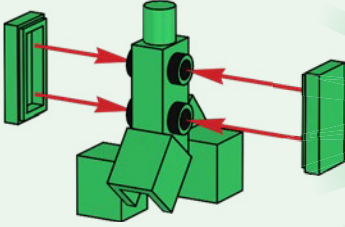

2

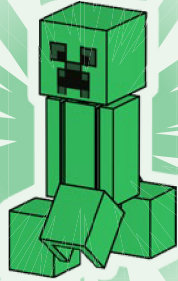

1

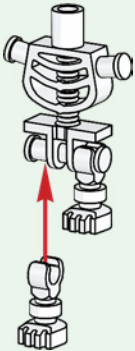

2

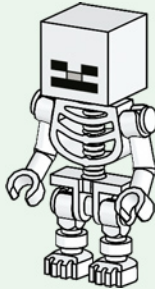

3

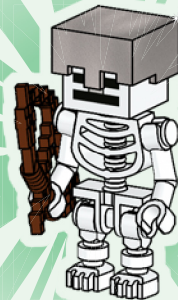

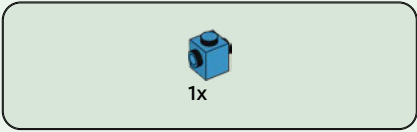

1



2

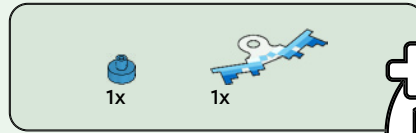
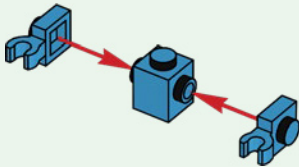

3

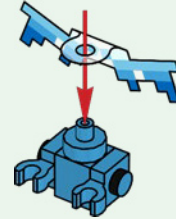
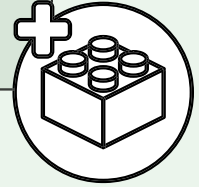

4

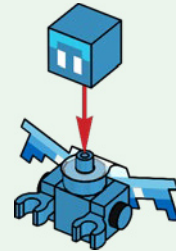



1x



1x

5

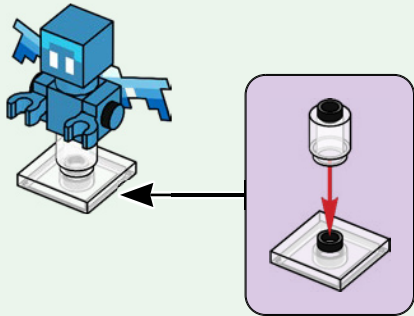

1x

6

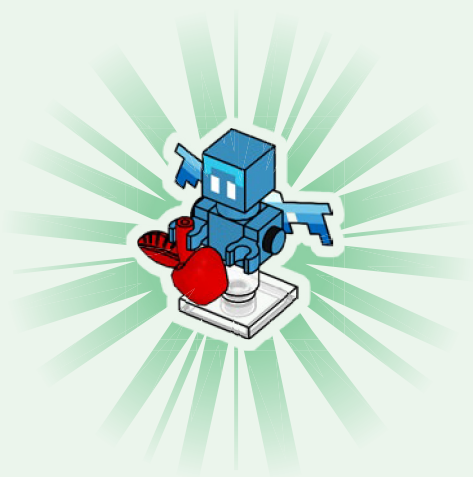

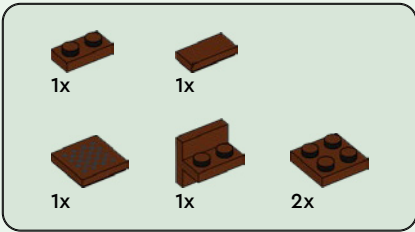

5

1



2

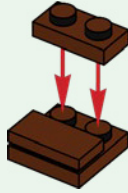

3

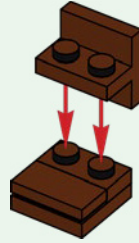

4

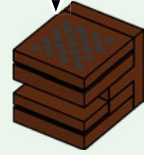
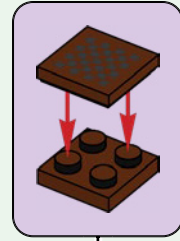



6

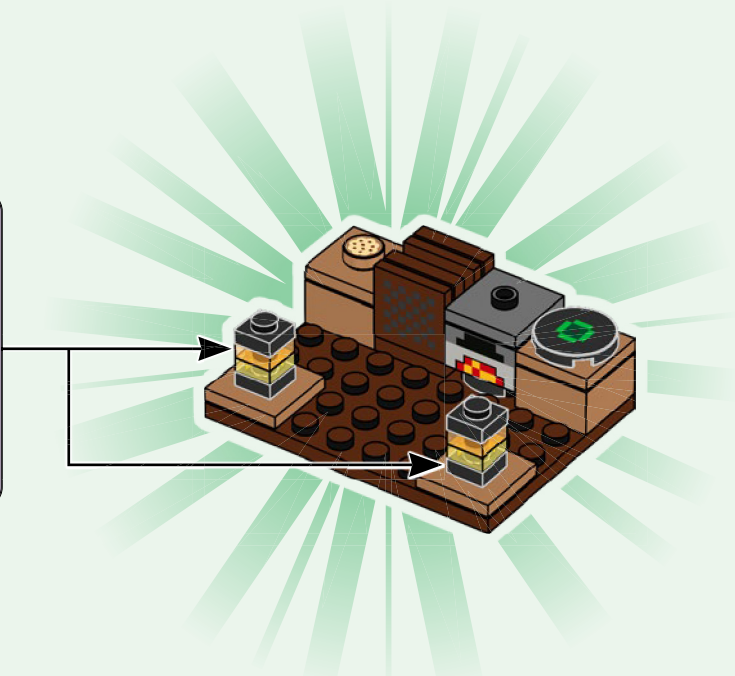
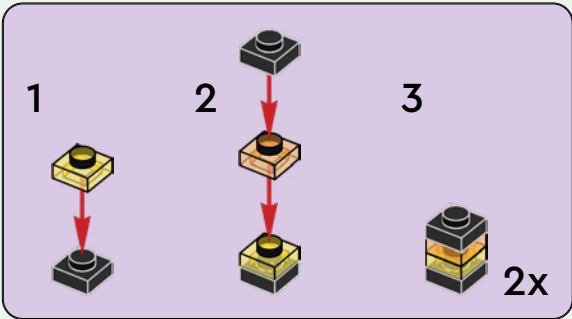

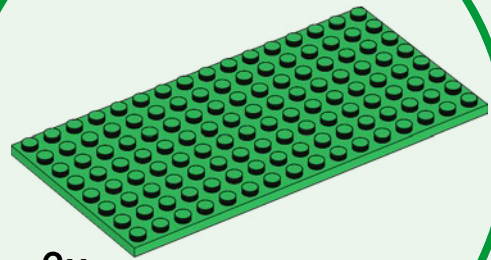
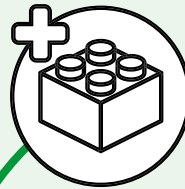

2x

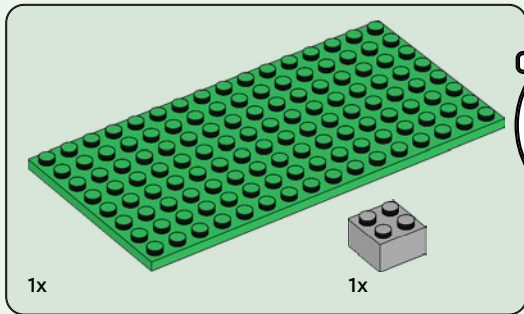
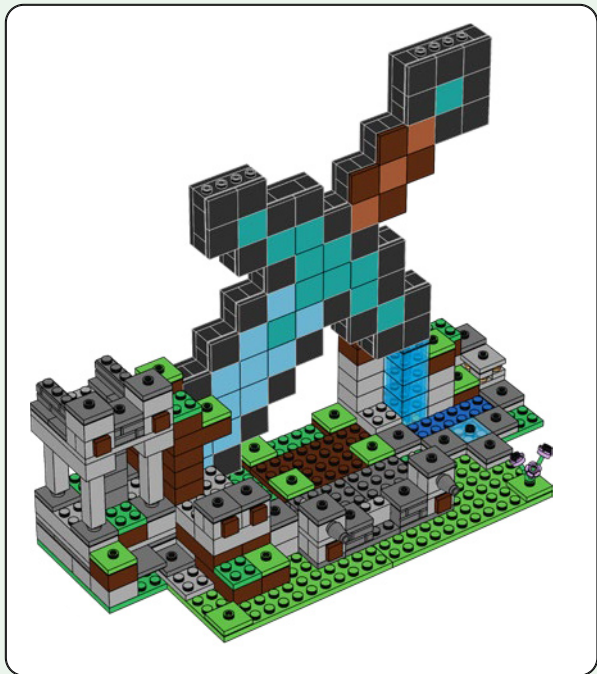

1

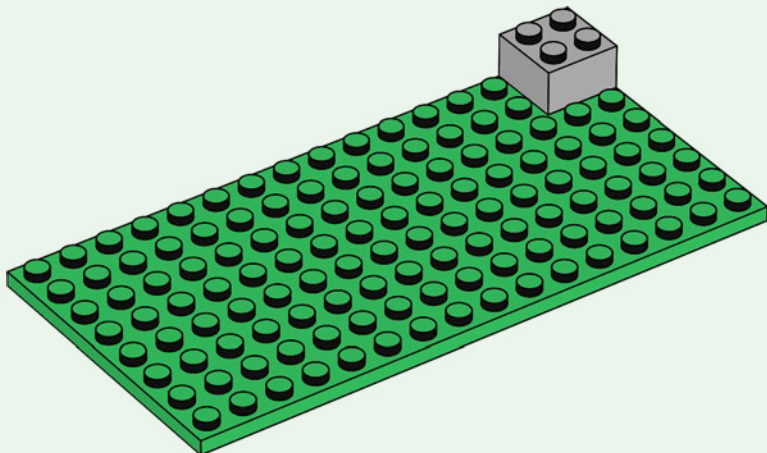

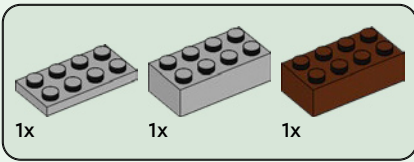

2

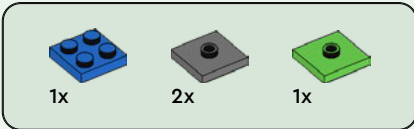
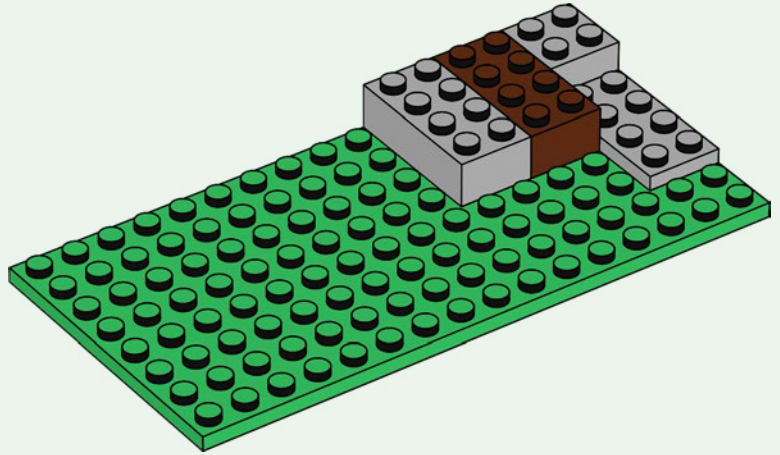

3

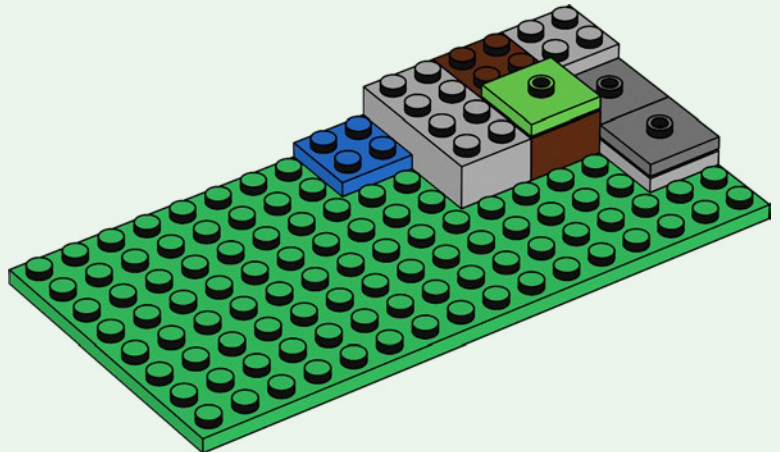

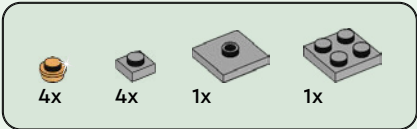

4

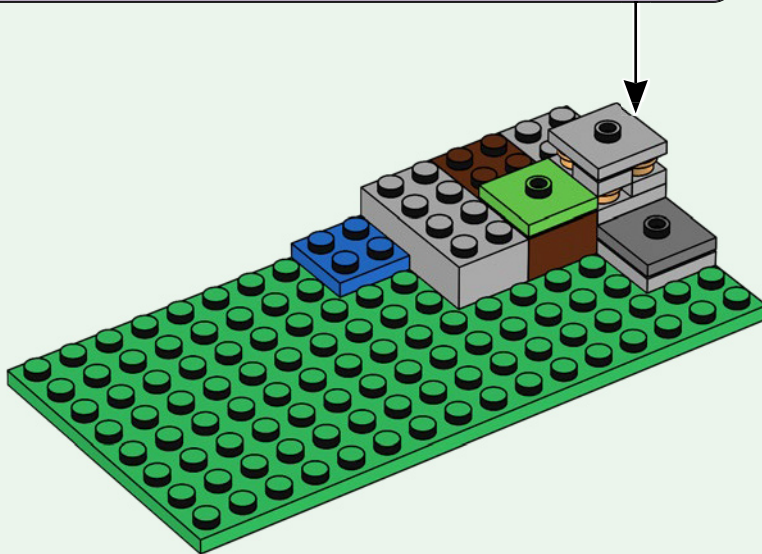
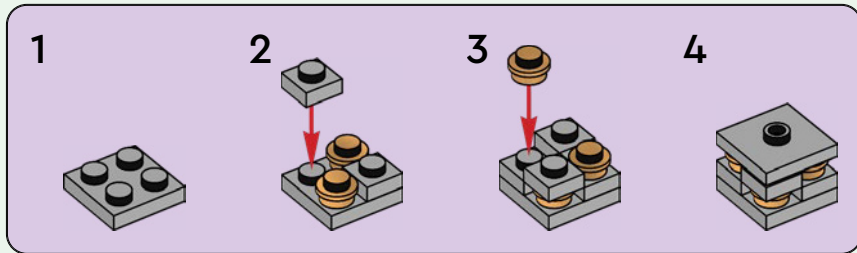

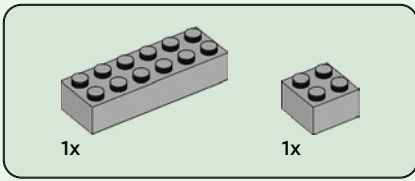

5

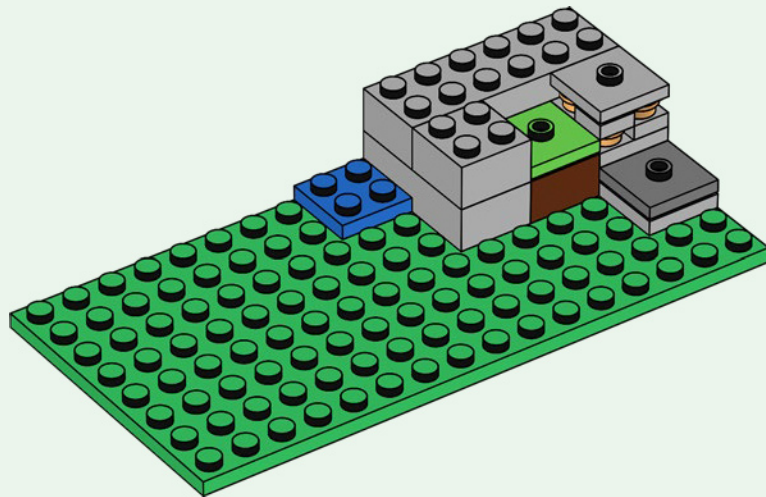

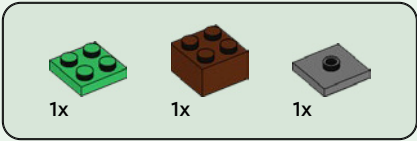

6

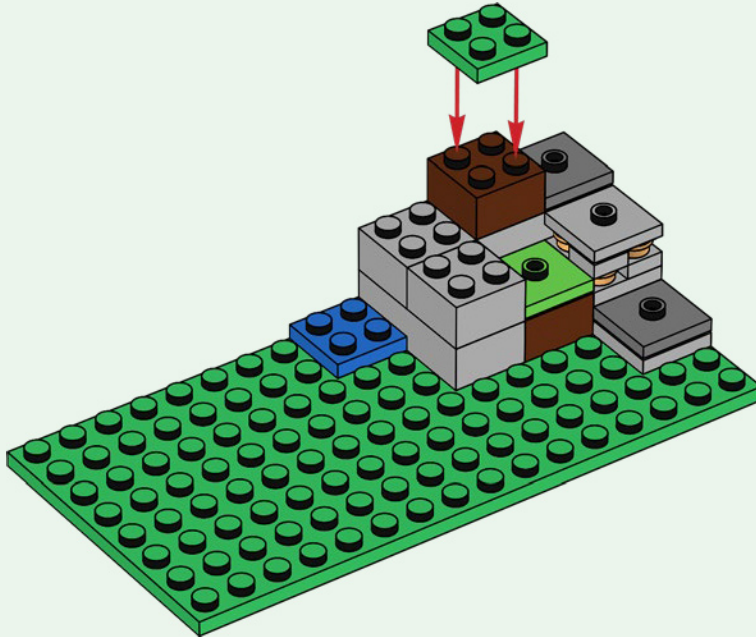

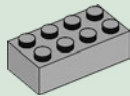

2x

7

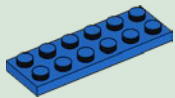
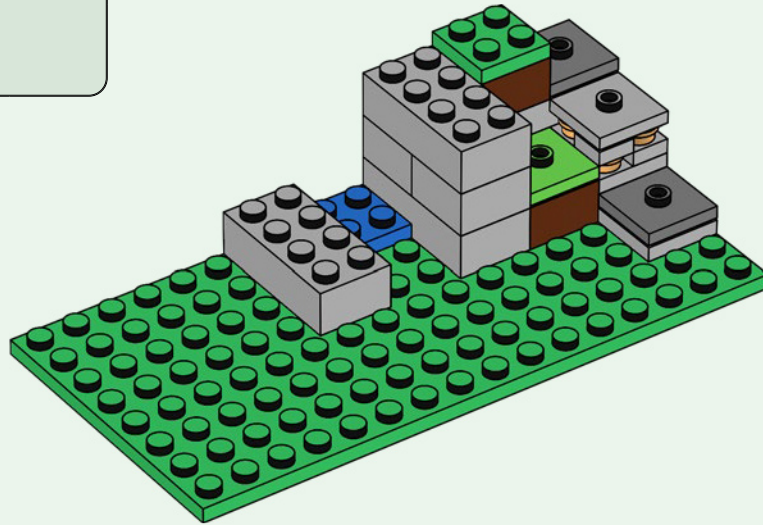

1x



1x



1x

8

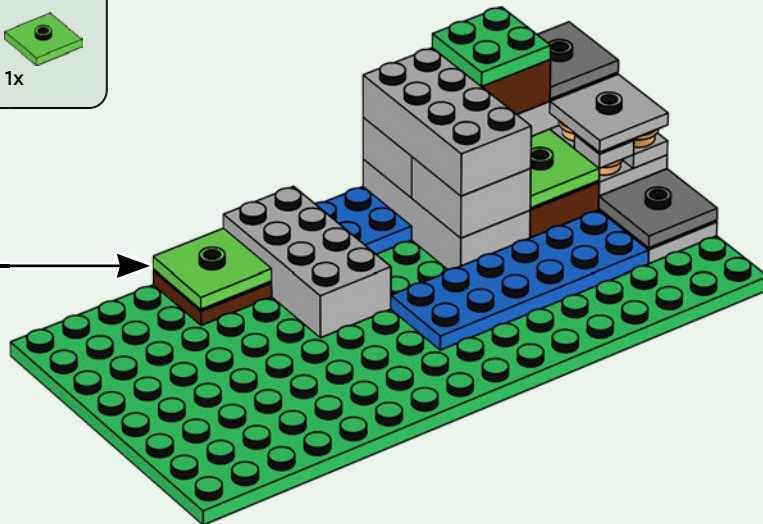
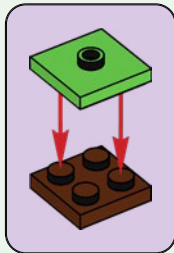



3x



3x

9

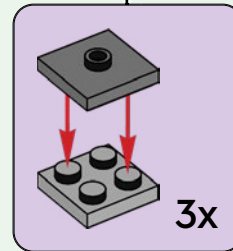
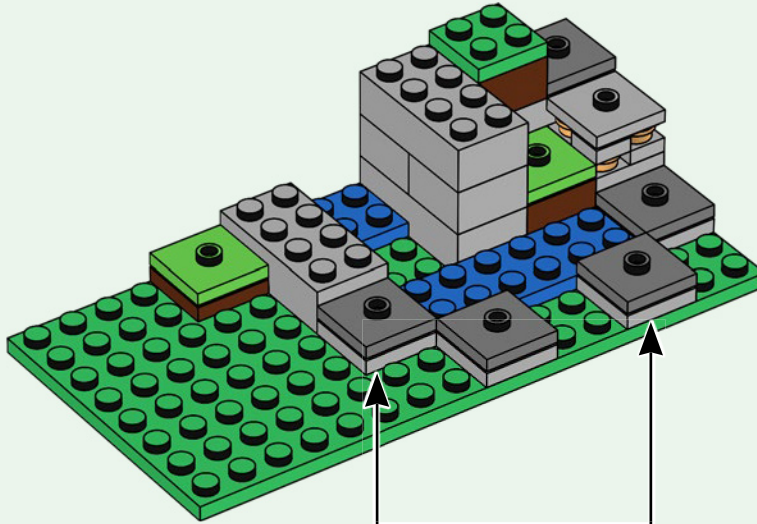

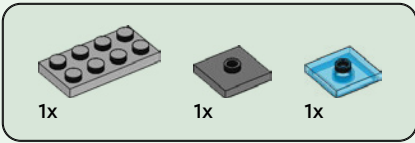

10

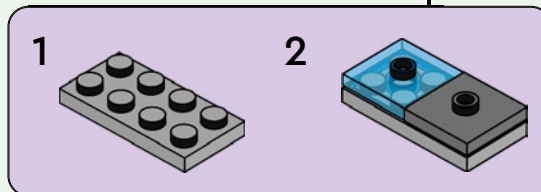
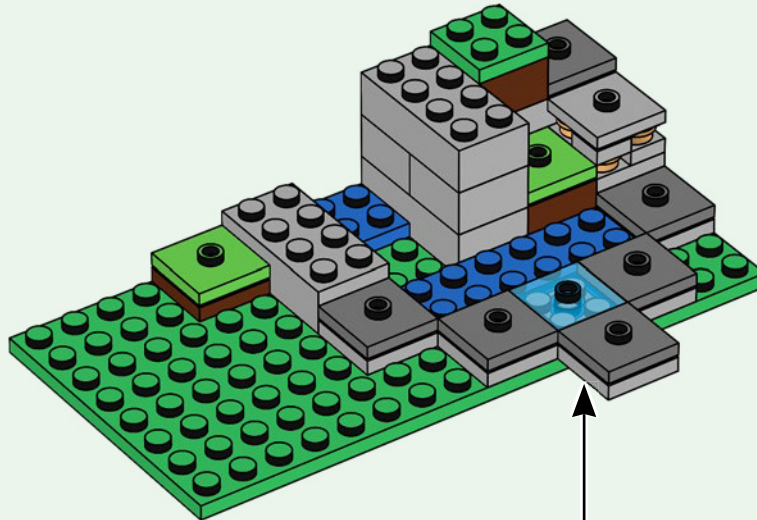



2x

11

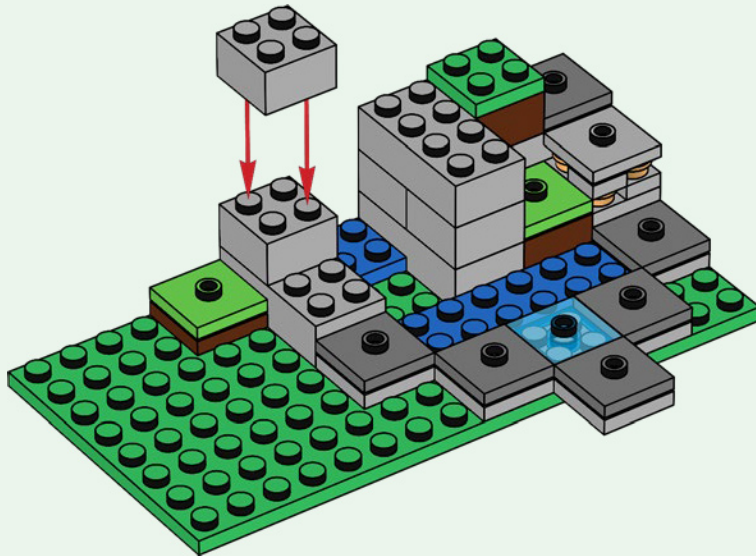

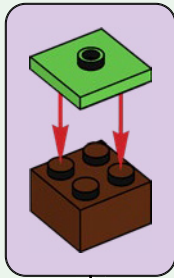
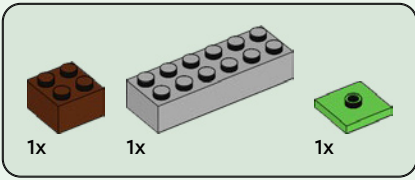

12

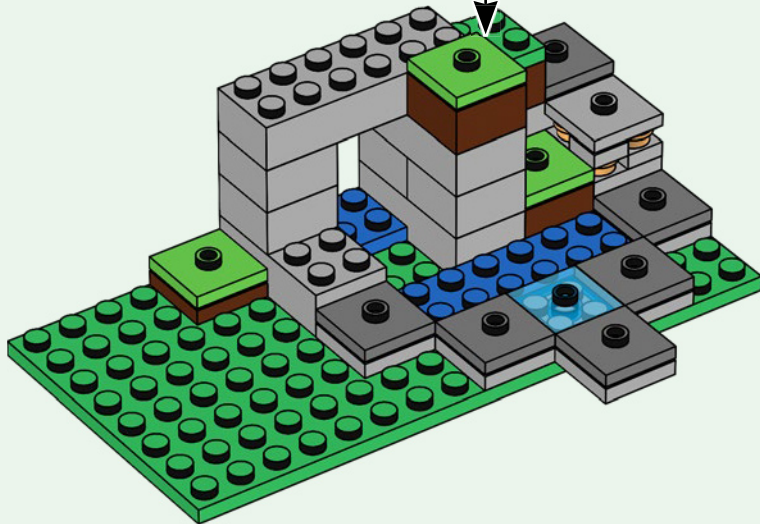

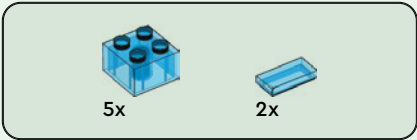

13

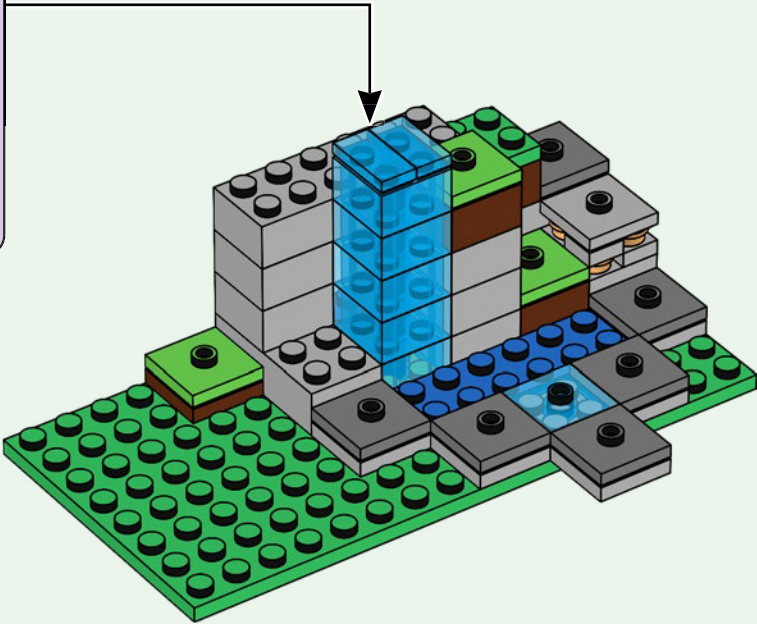
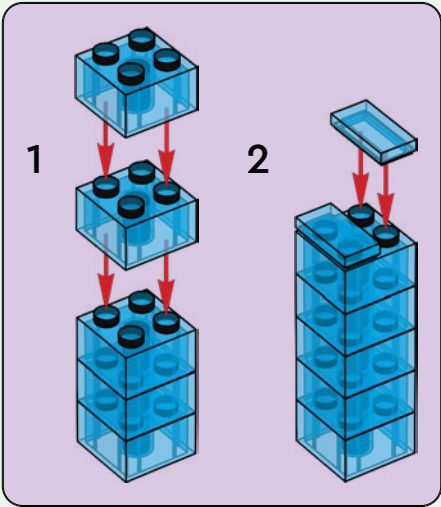

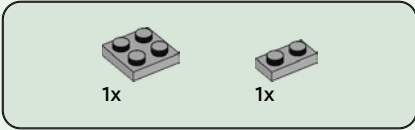

14

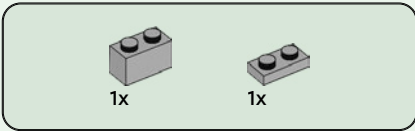
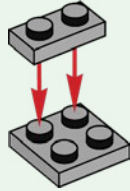

15

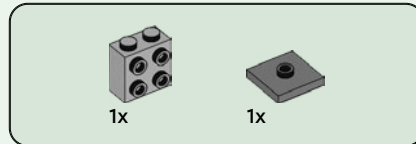
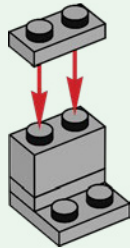

16

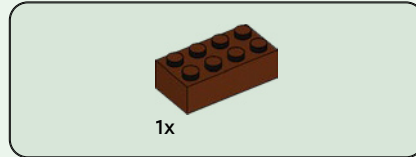
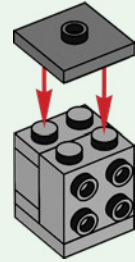

17

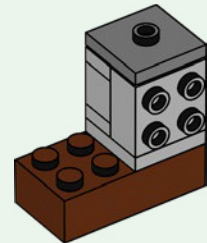

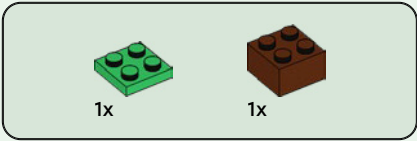

18

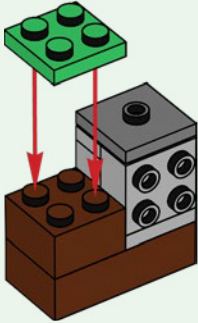

19

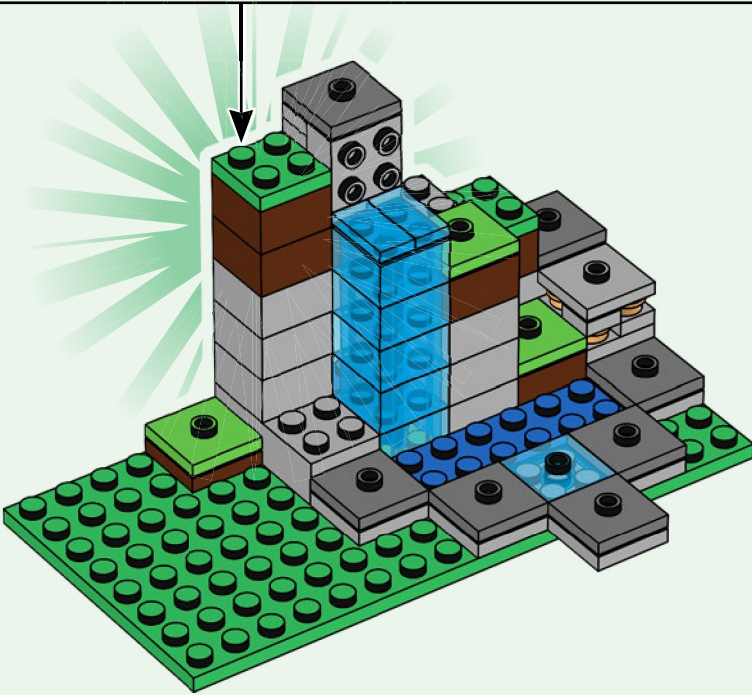

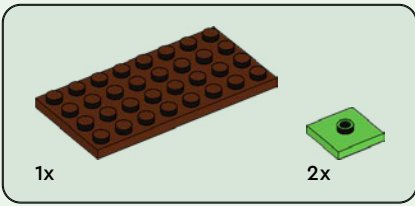

20

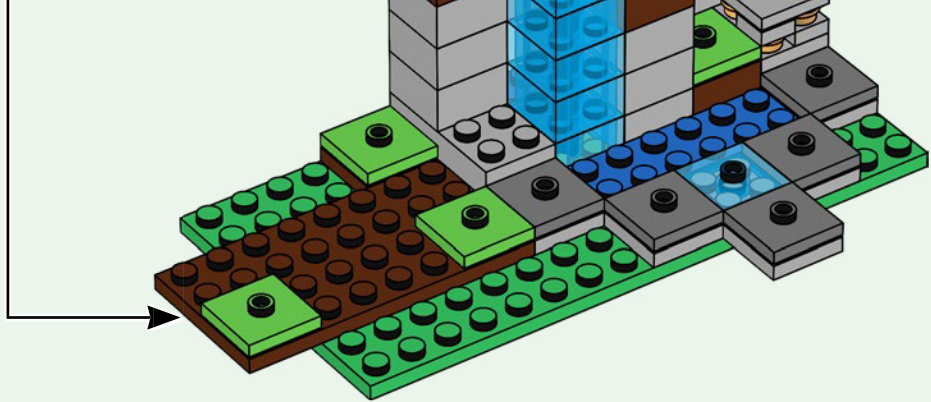
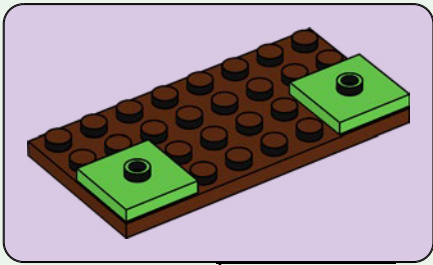

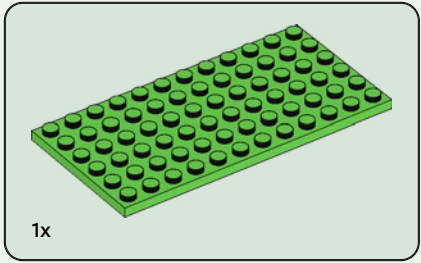

21

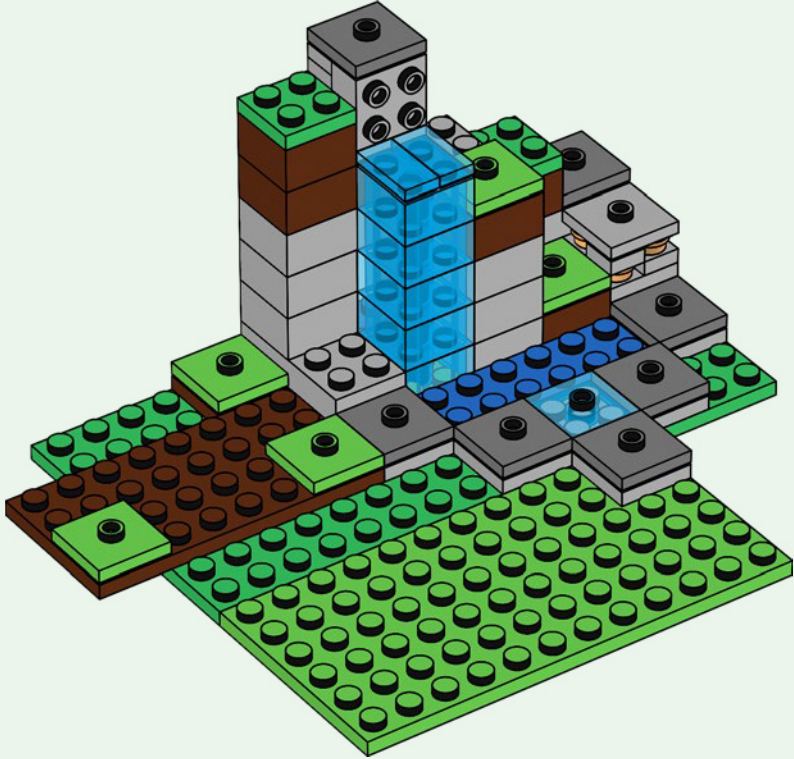

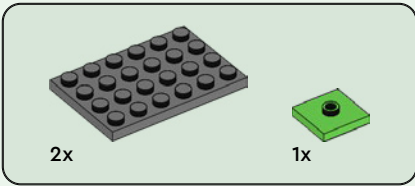

22

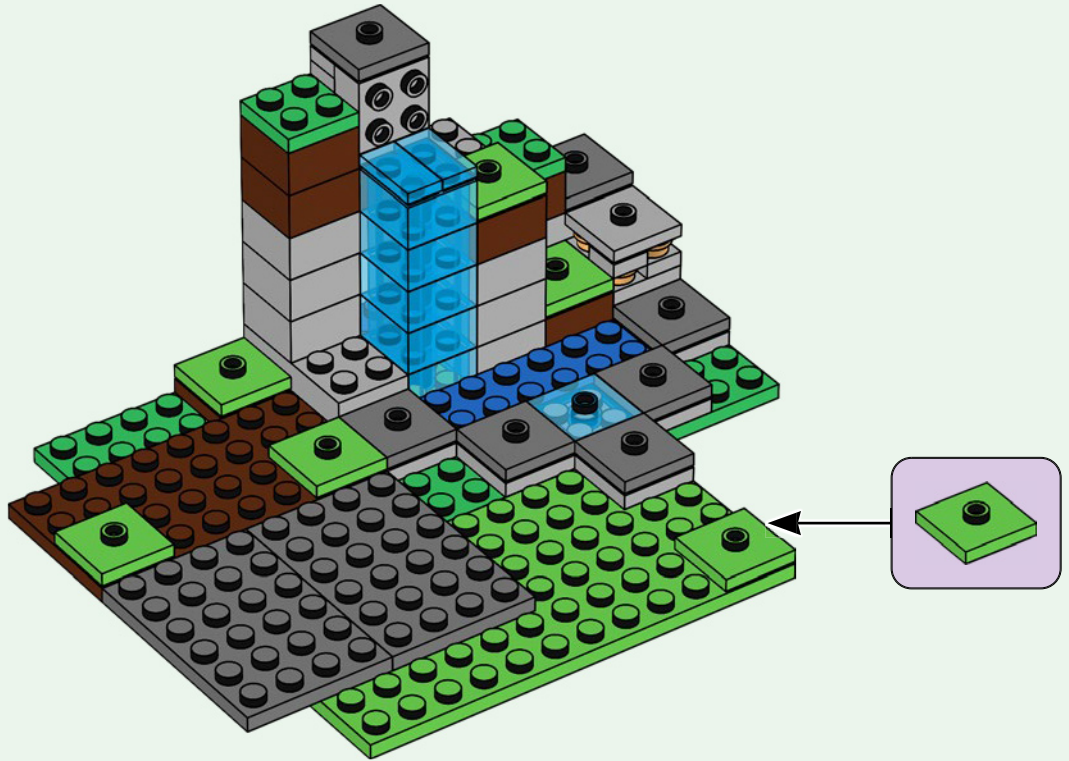

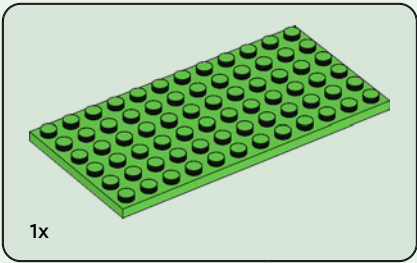

23

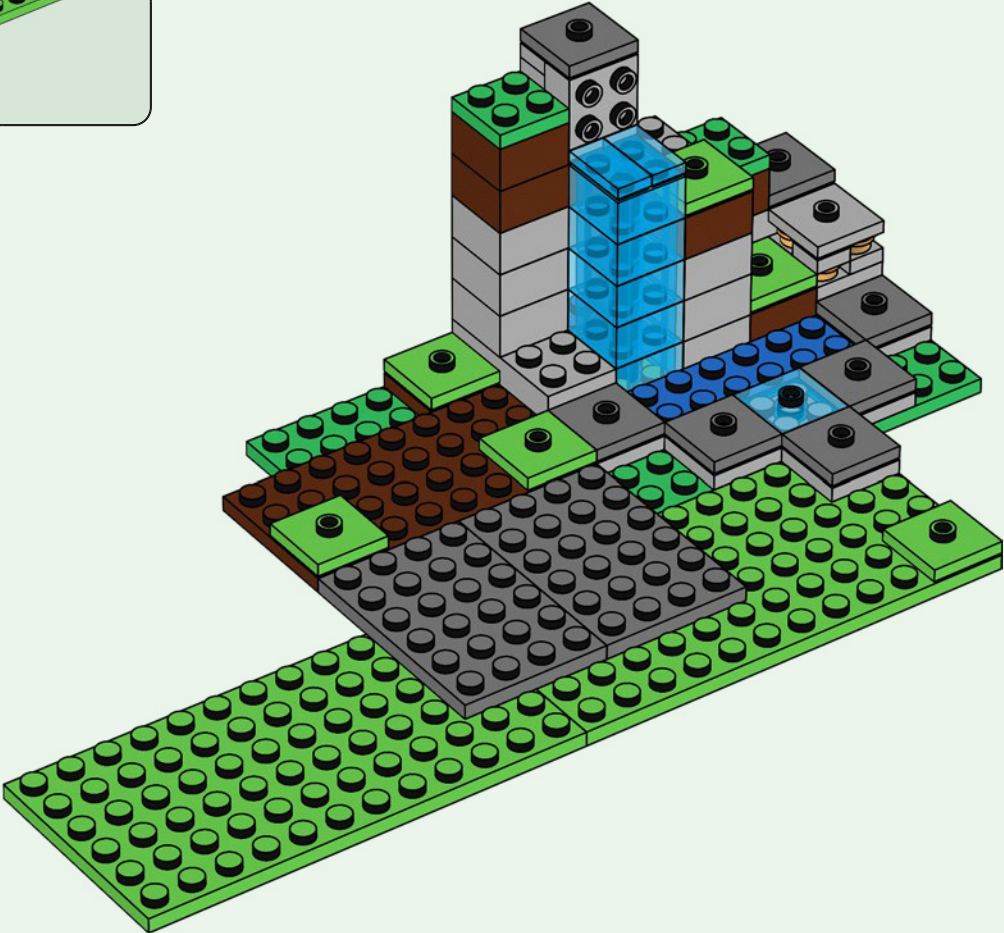

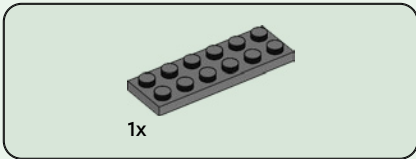

24

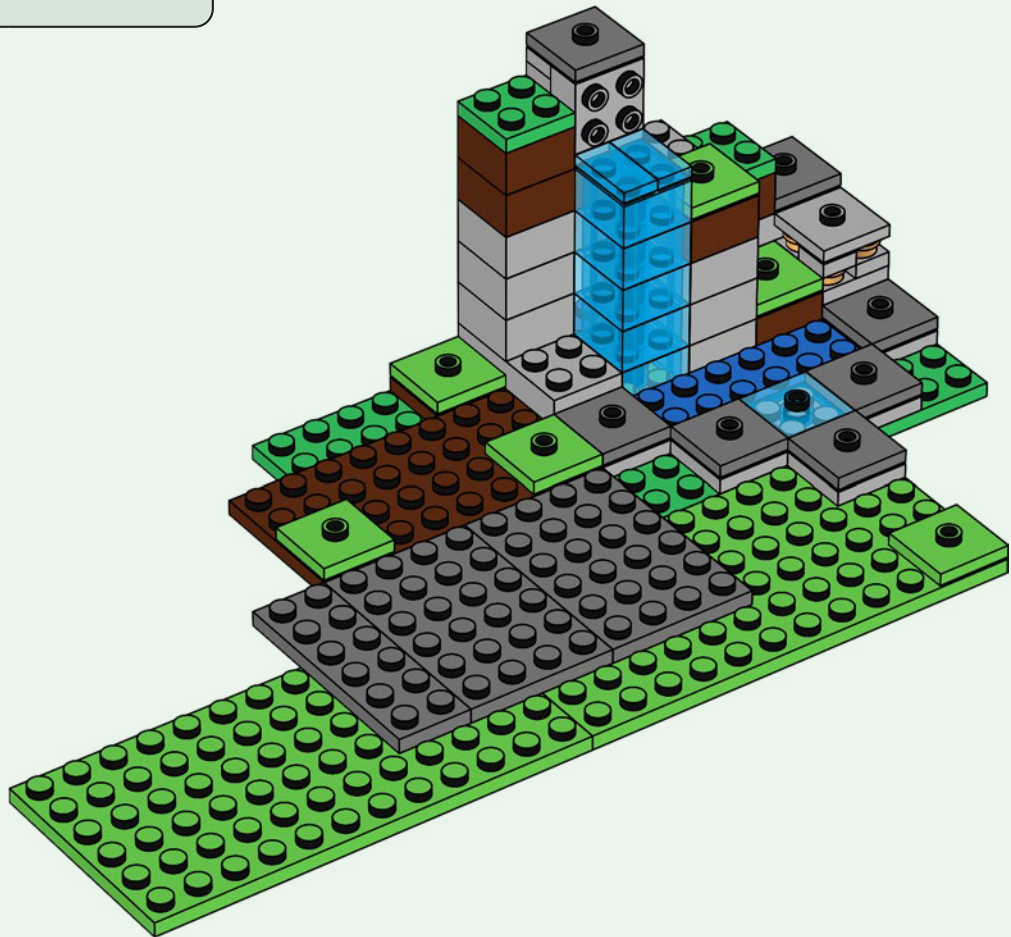

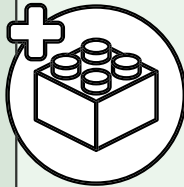
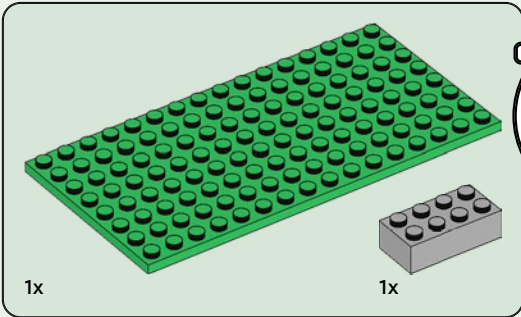
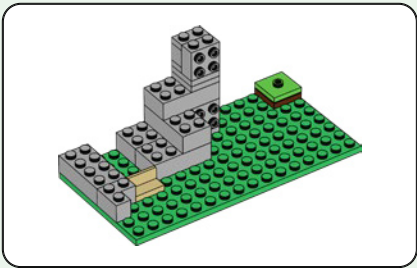

25

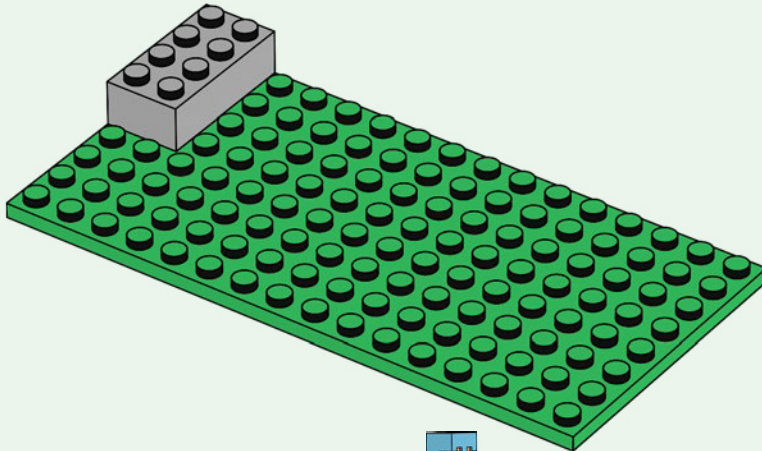

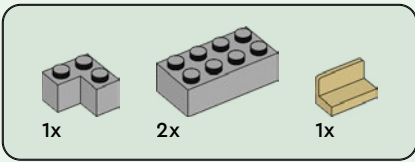

26

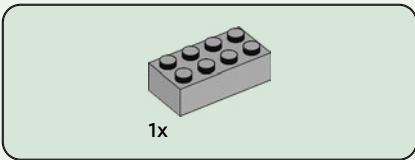
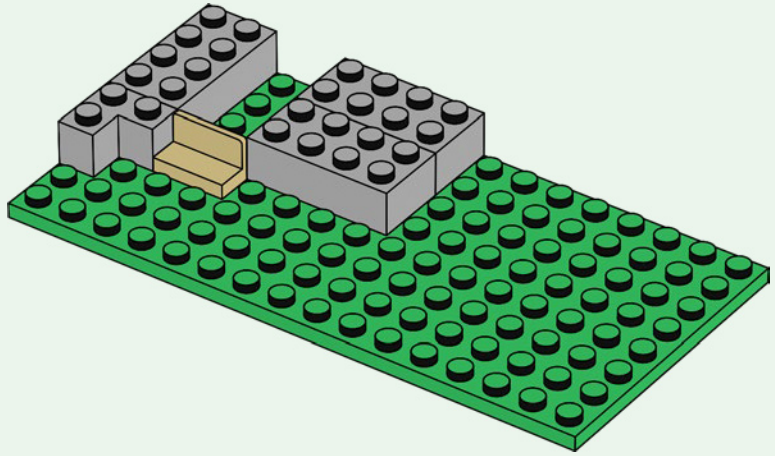

27

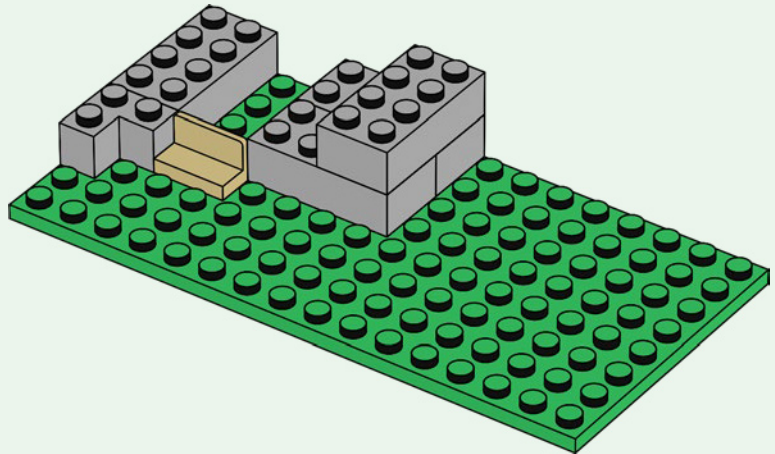

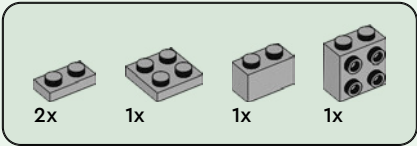

28

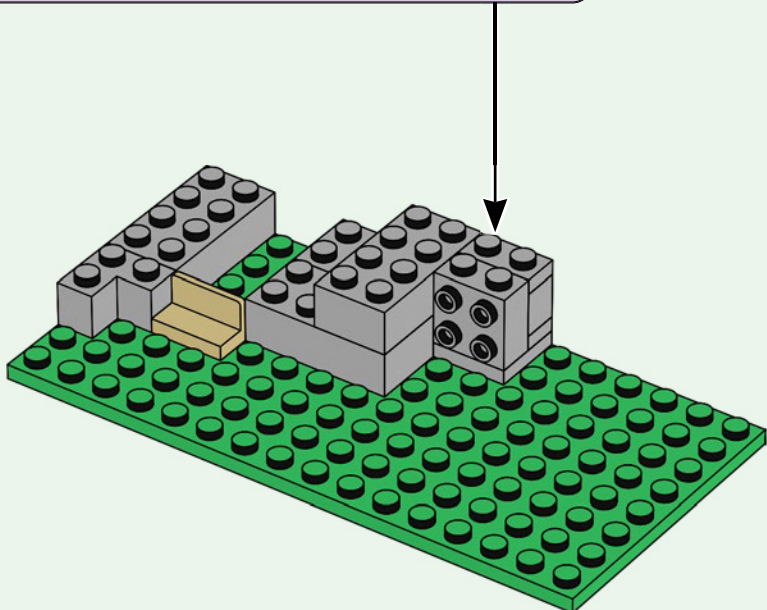
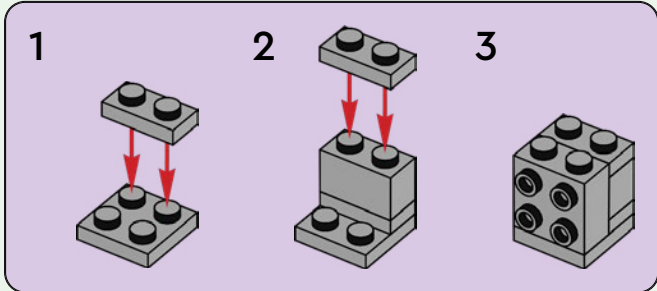

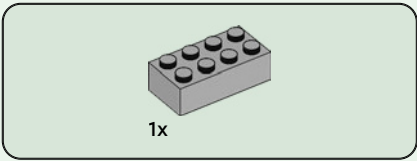

29

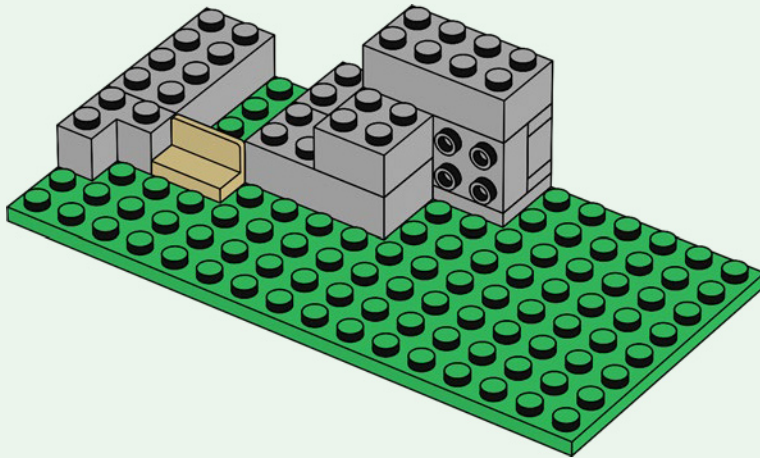

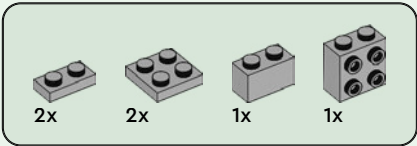

30

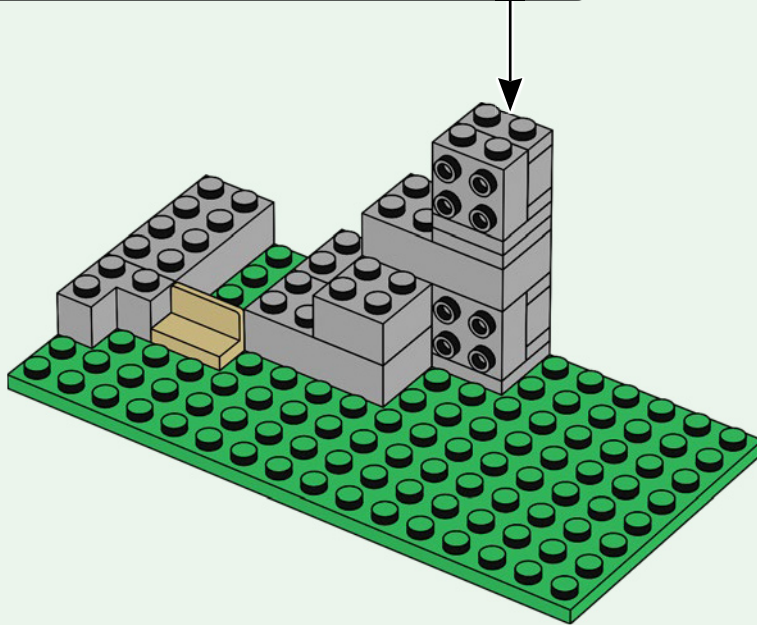
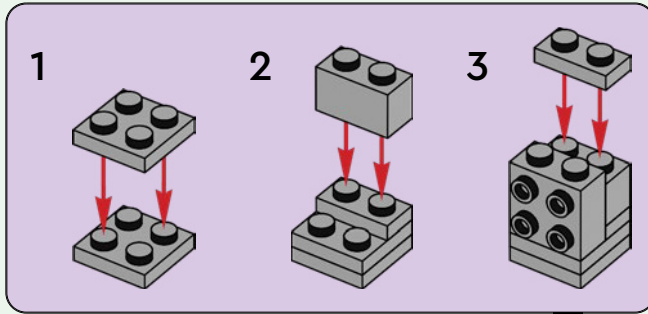

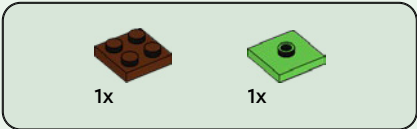

31

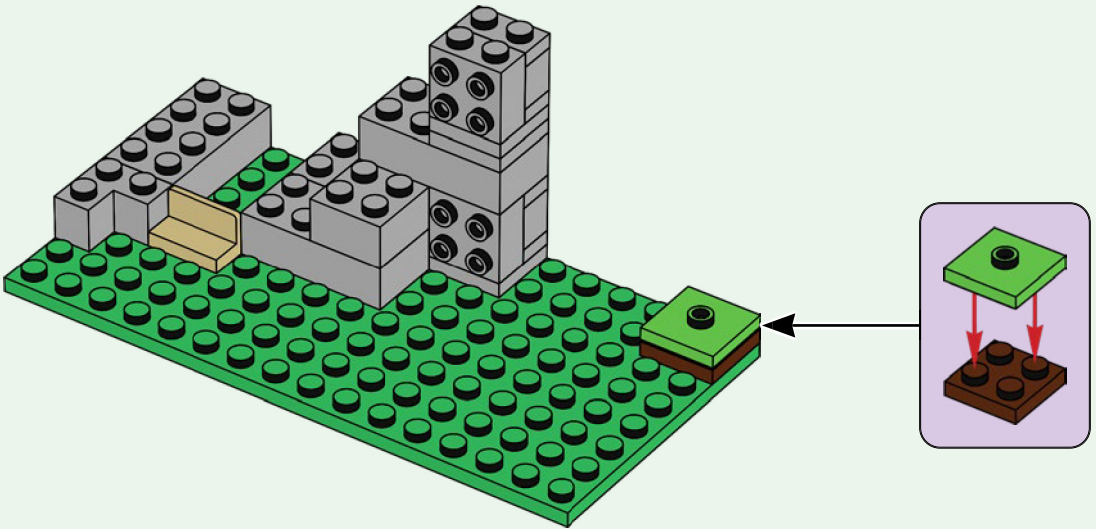

32

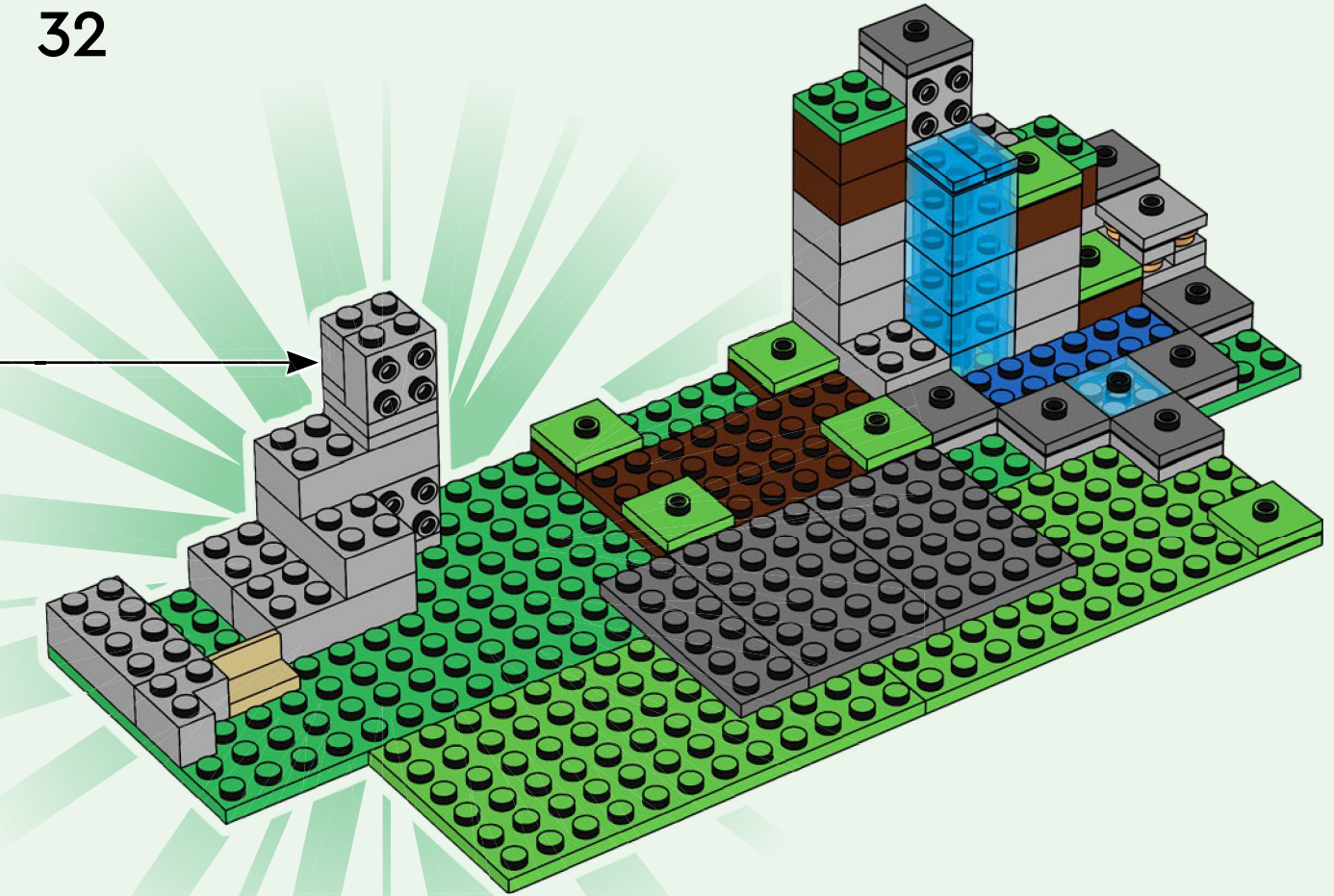



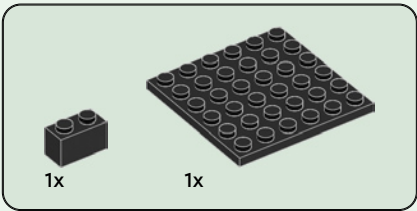
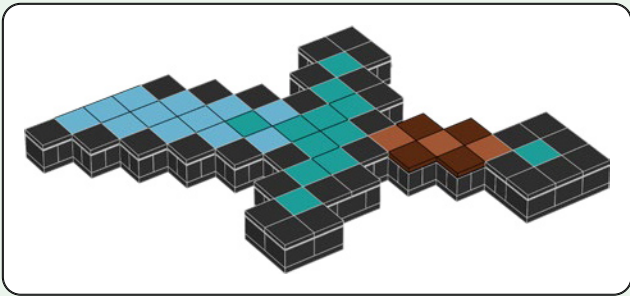

33

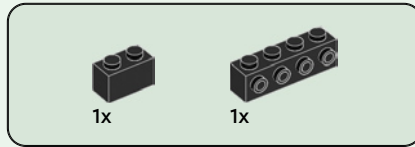
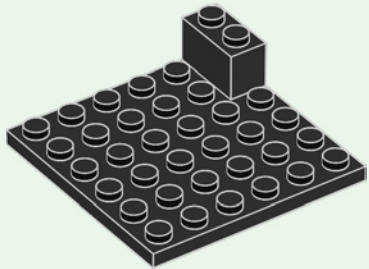

34

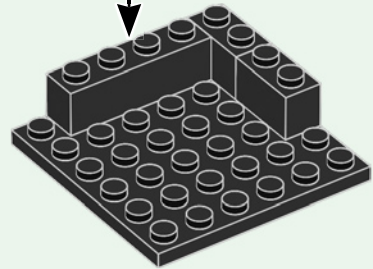
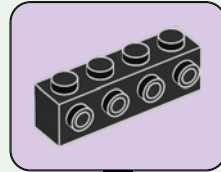

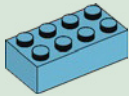

2x

35

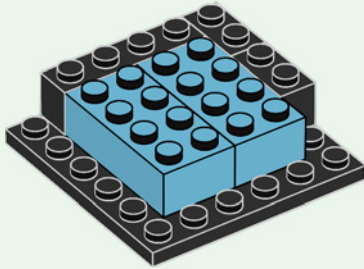

1x



1x



2x

36

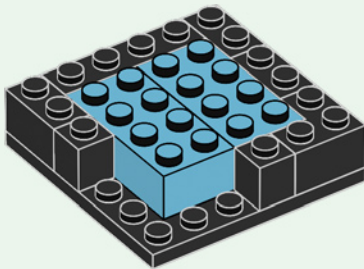

2x

37

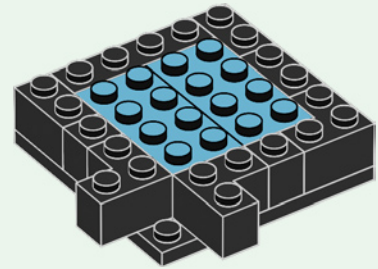

7x



1x

38

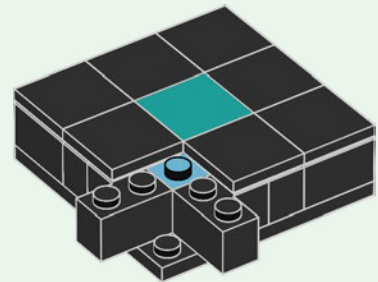



1x

39

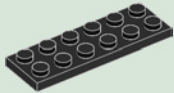
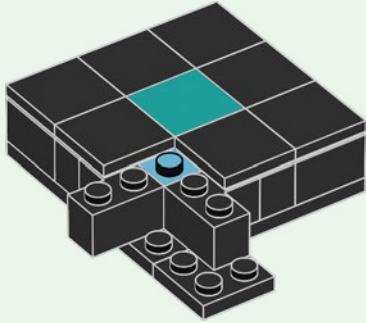

1x

40

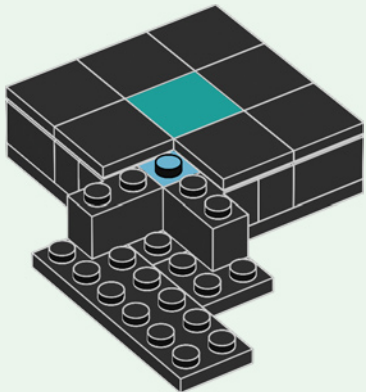

2x



1x

41

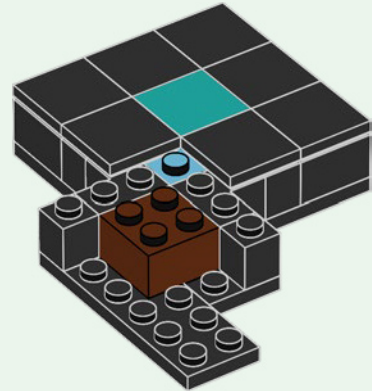



2x

42

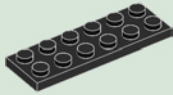
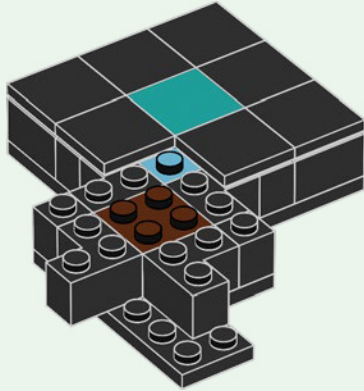

1x

43

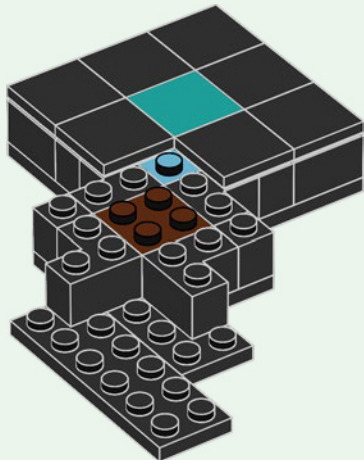

2x



2x



1x

44

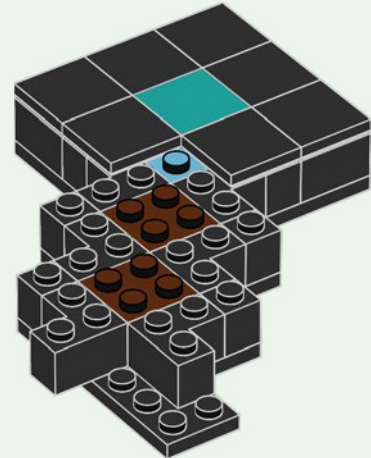

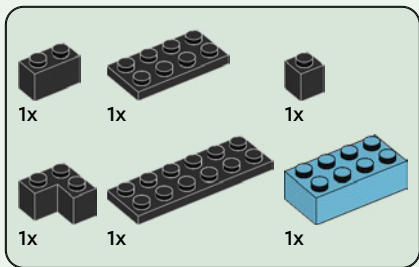

45

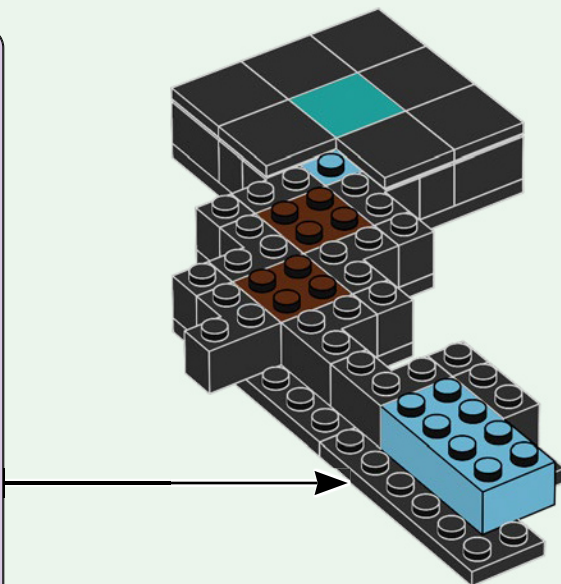
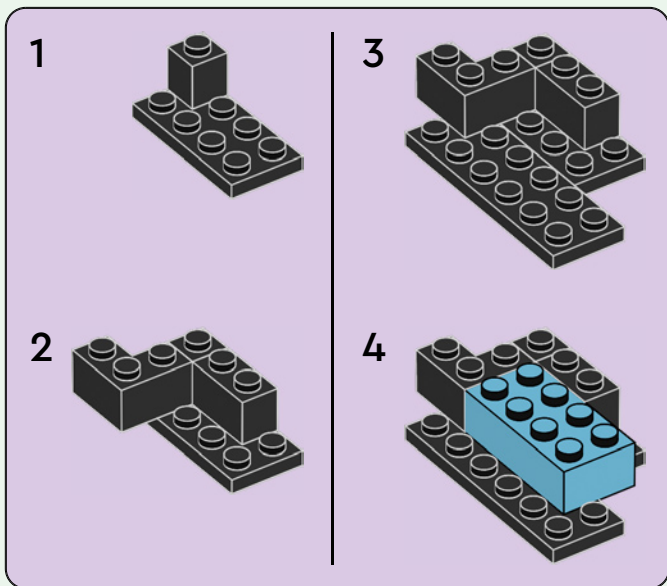

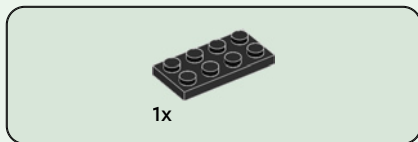

46

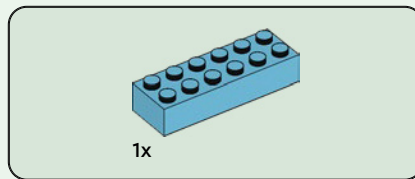
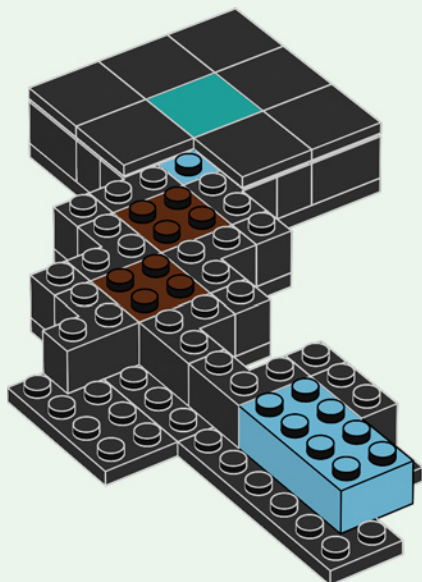

47



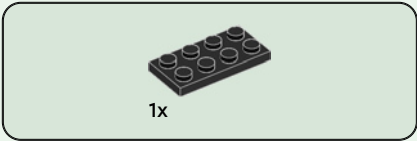

48

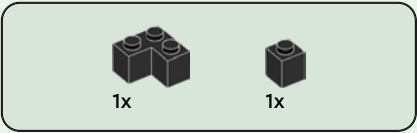
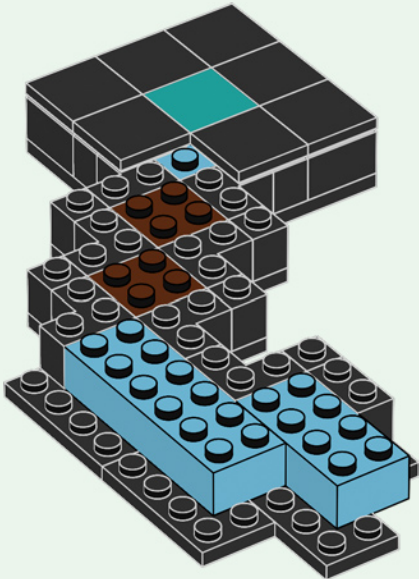

49

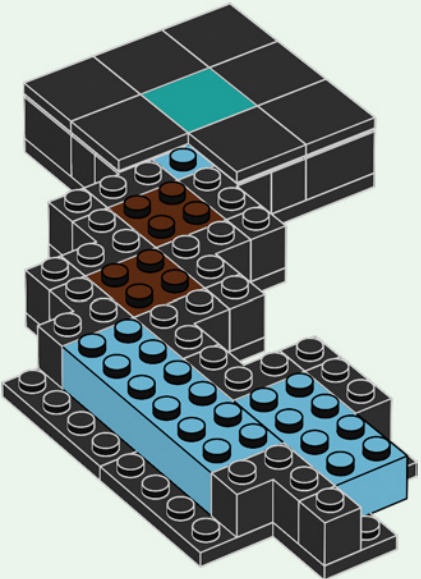

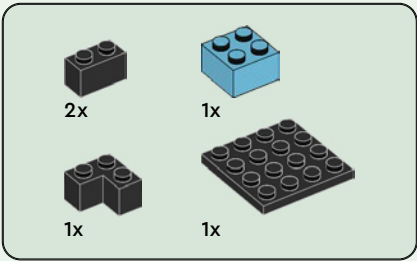

50

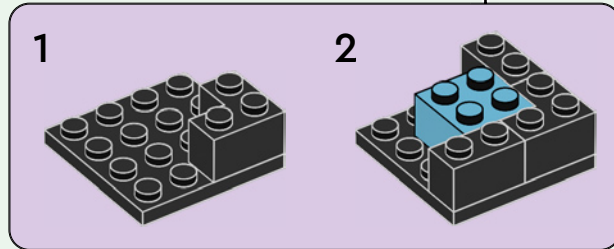
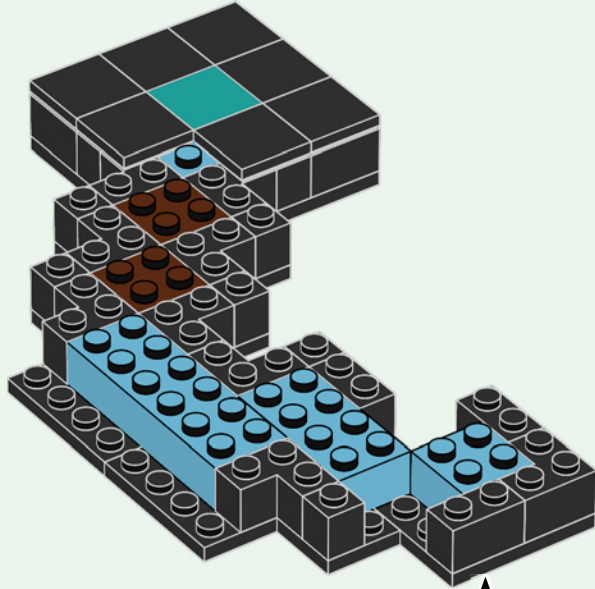



2x

51

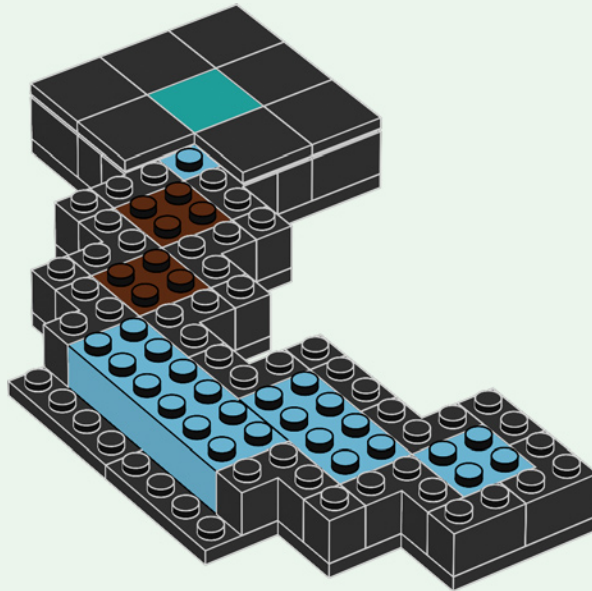

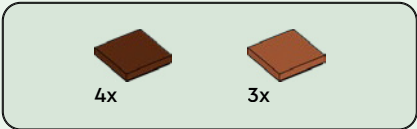

52

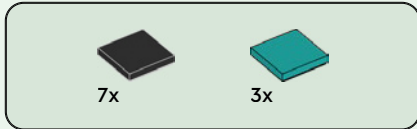
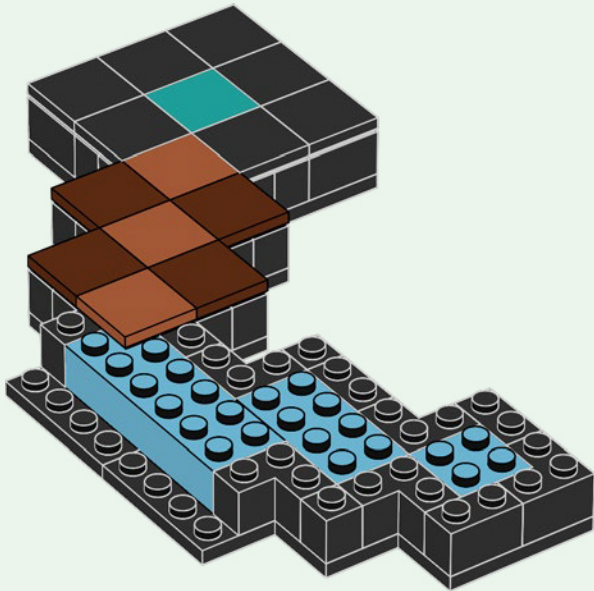

53

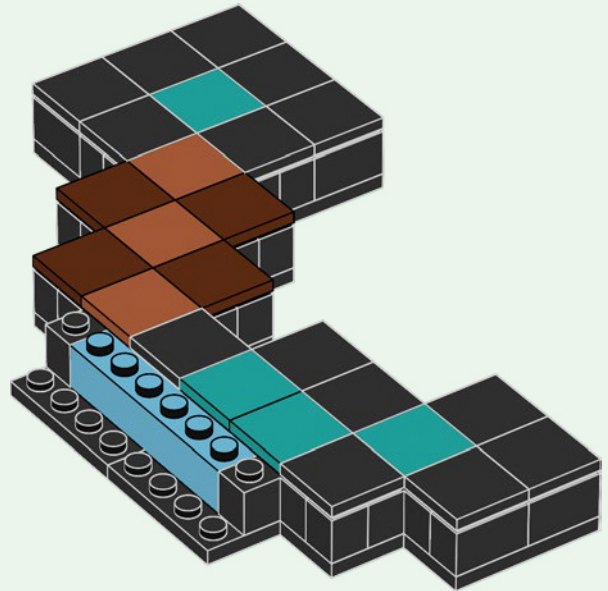

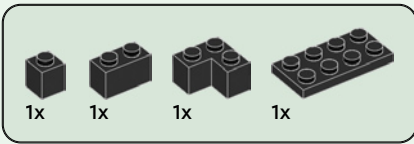

55

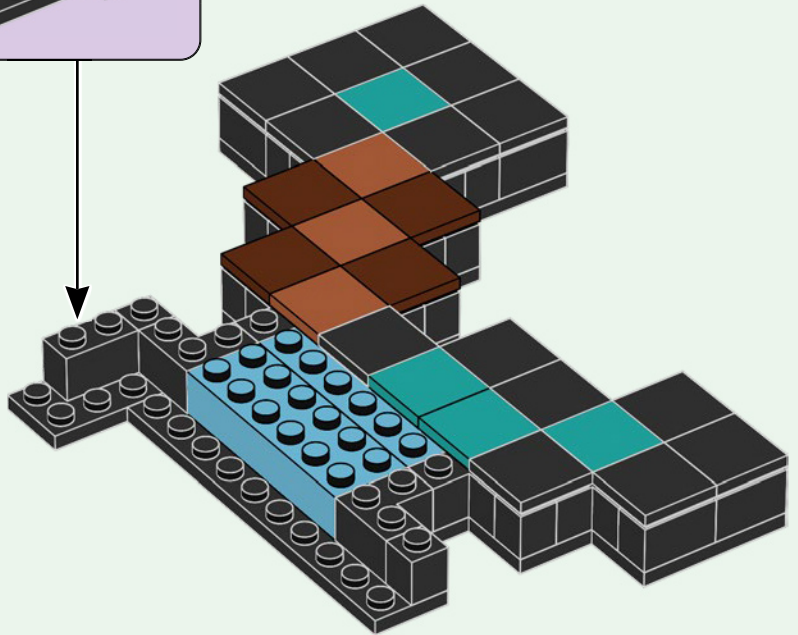
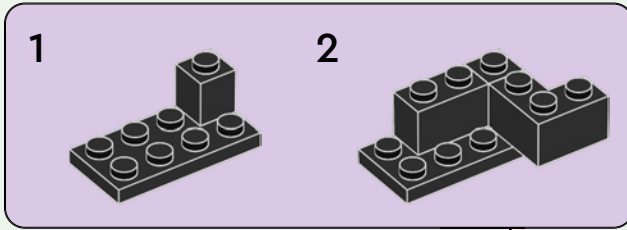

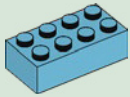

1x

56

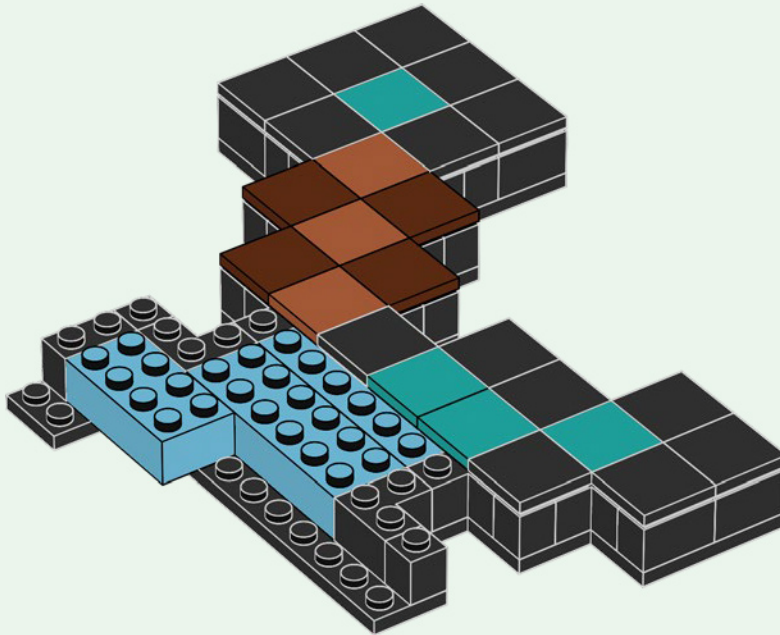



1x

57

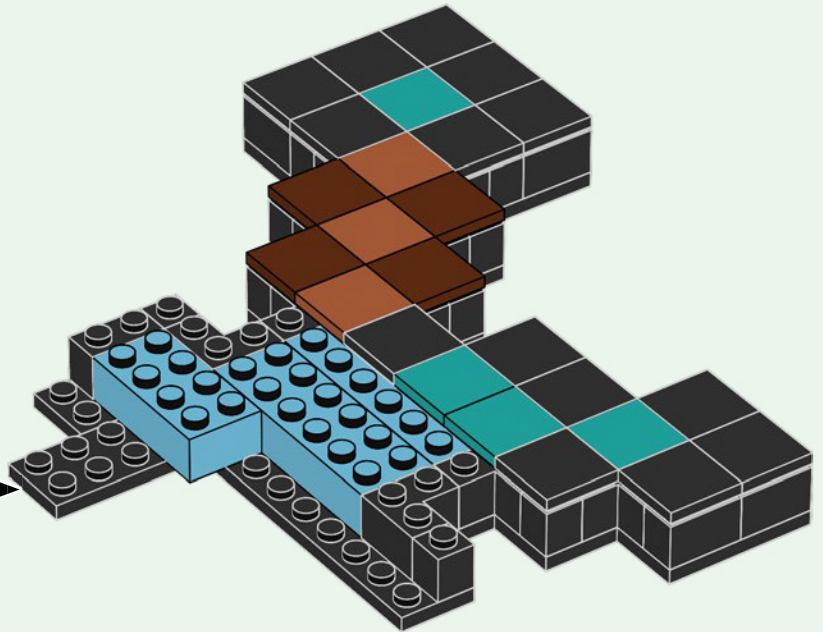
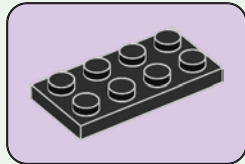



1x

58

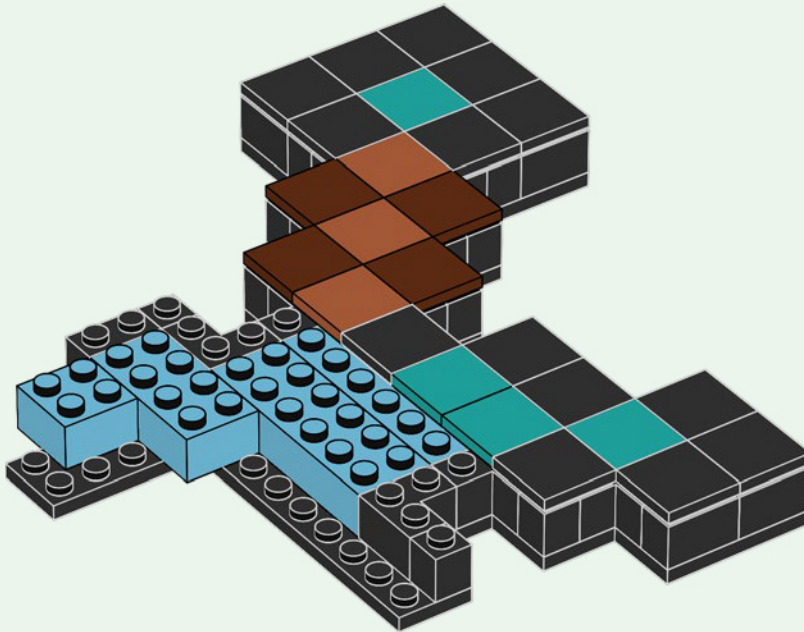

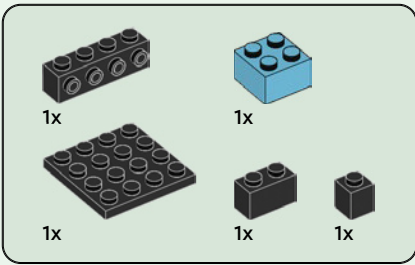

59

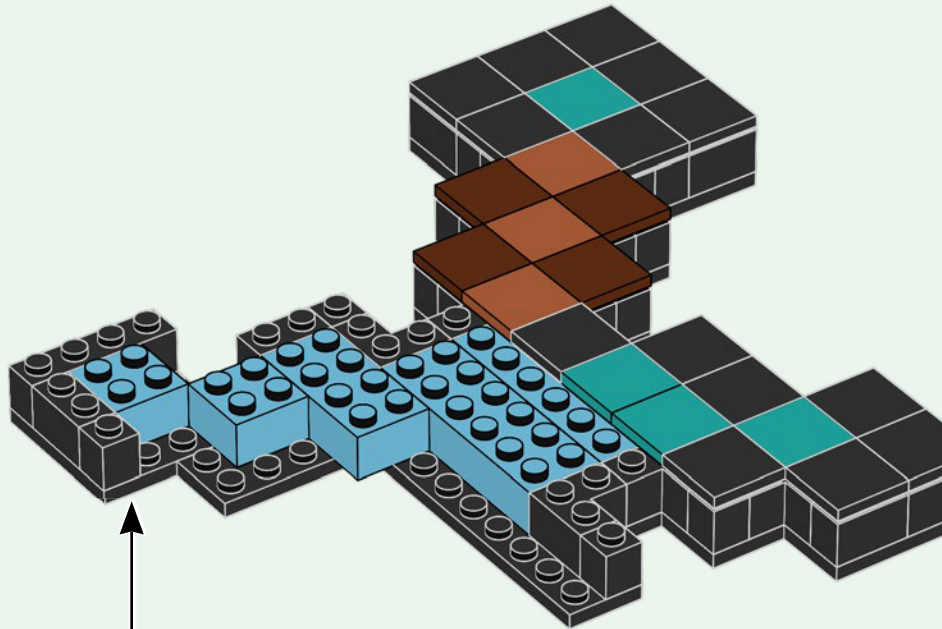
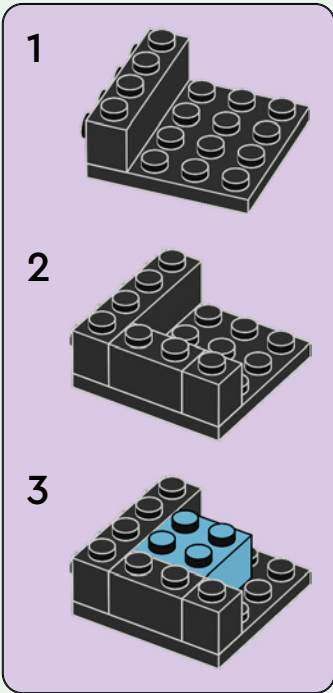



2x

60

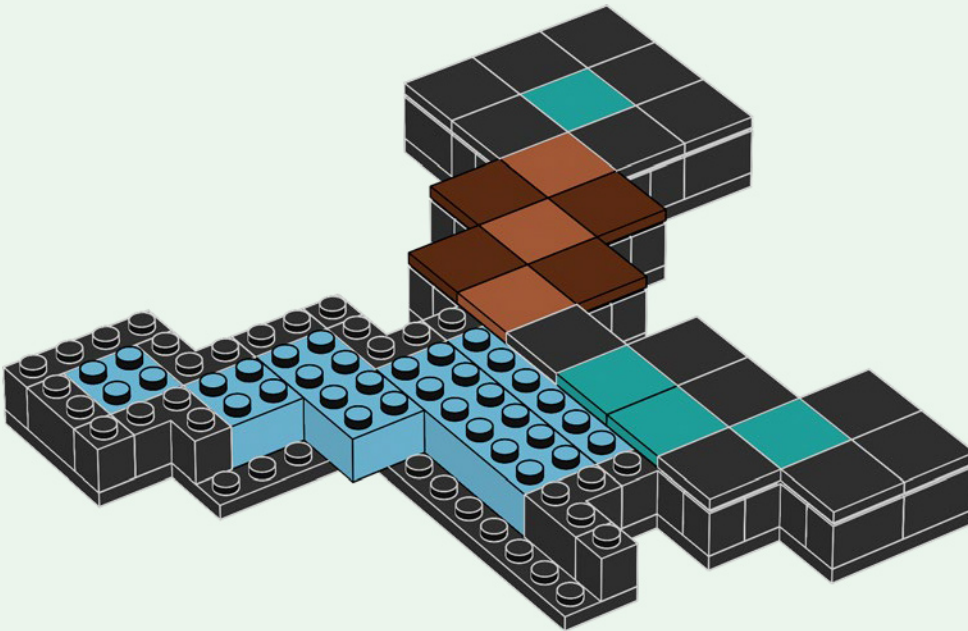

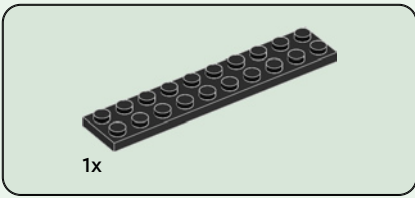

61

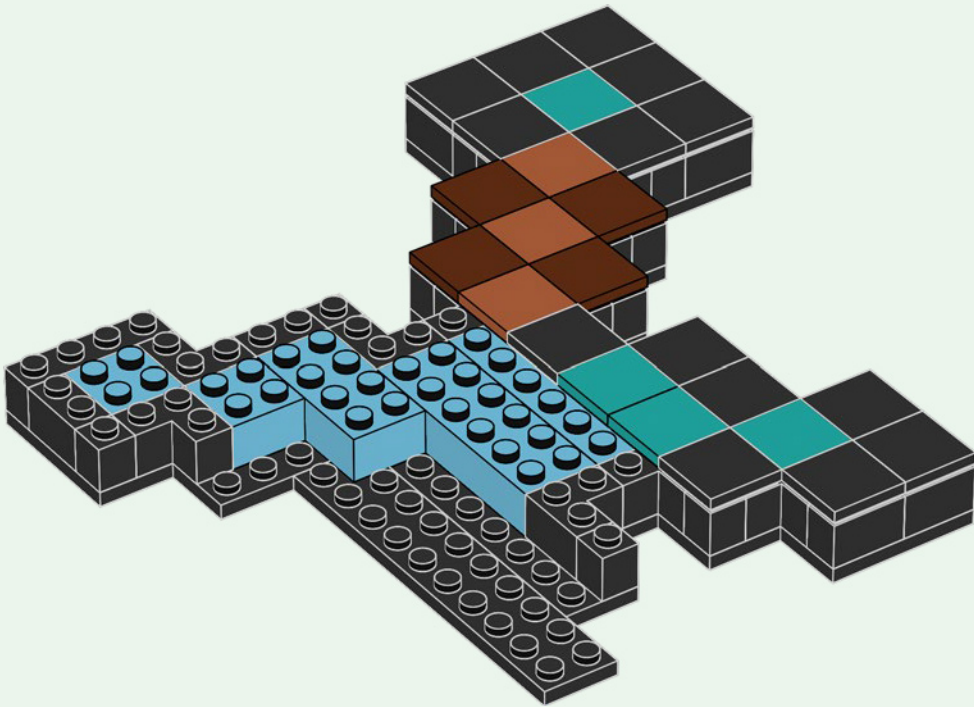

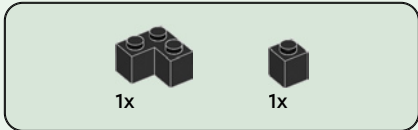

62

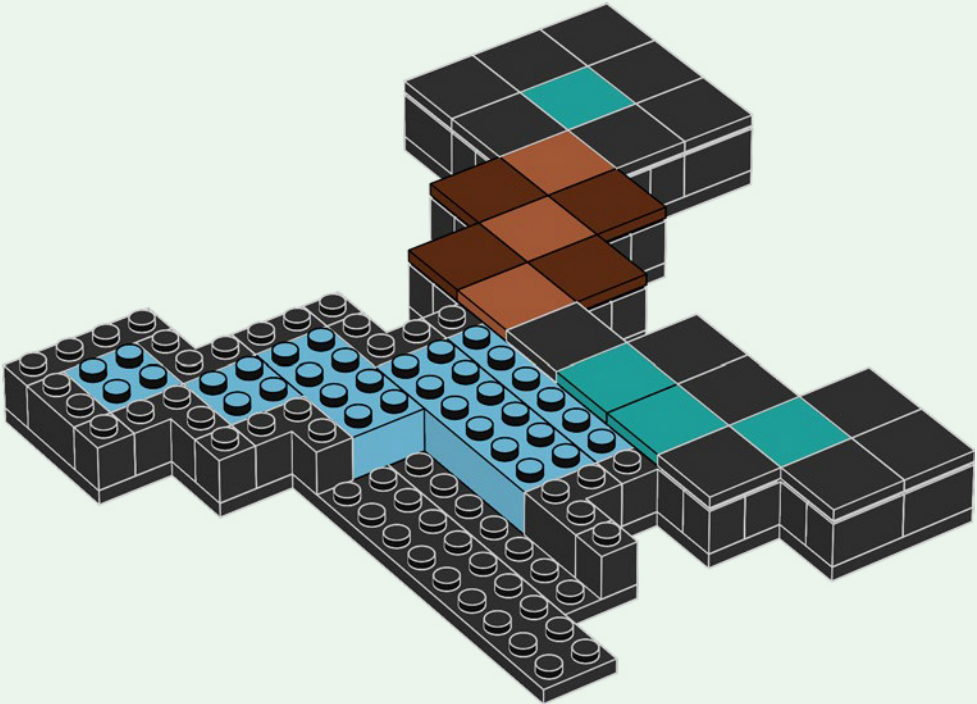

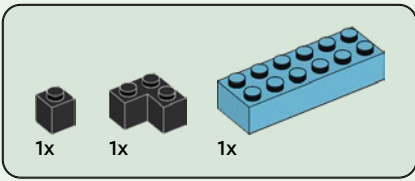

63

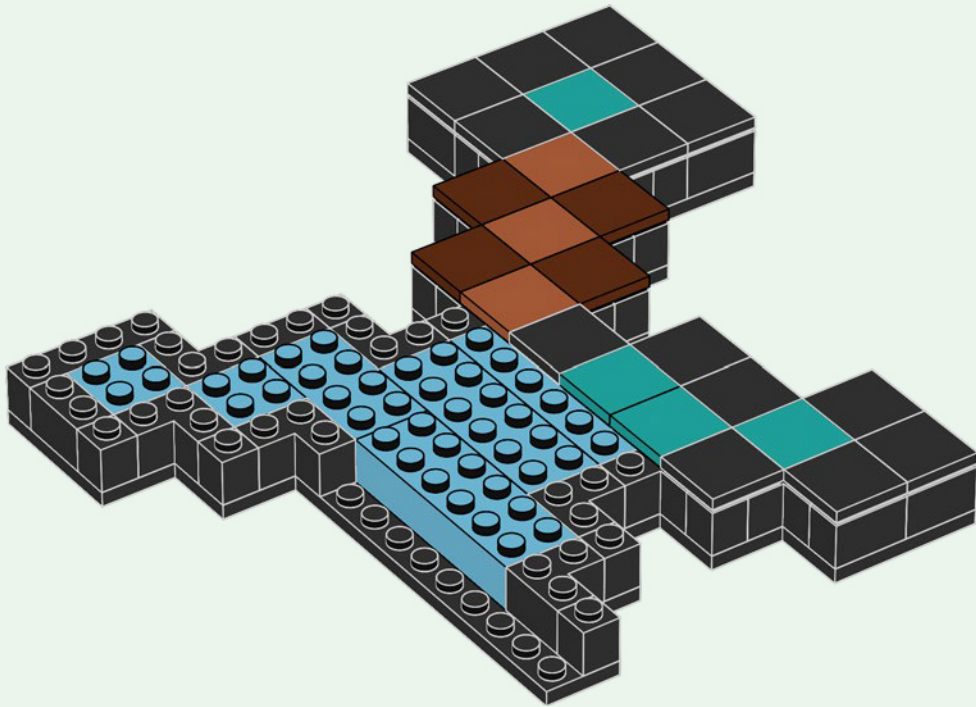

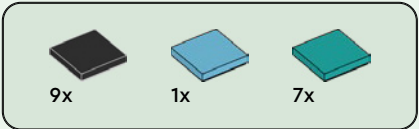

64

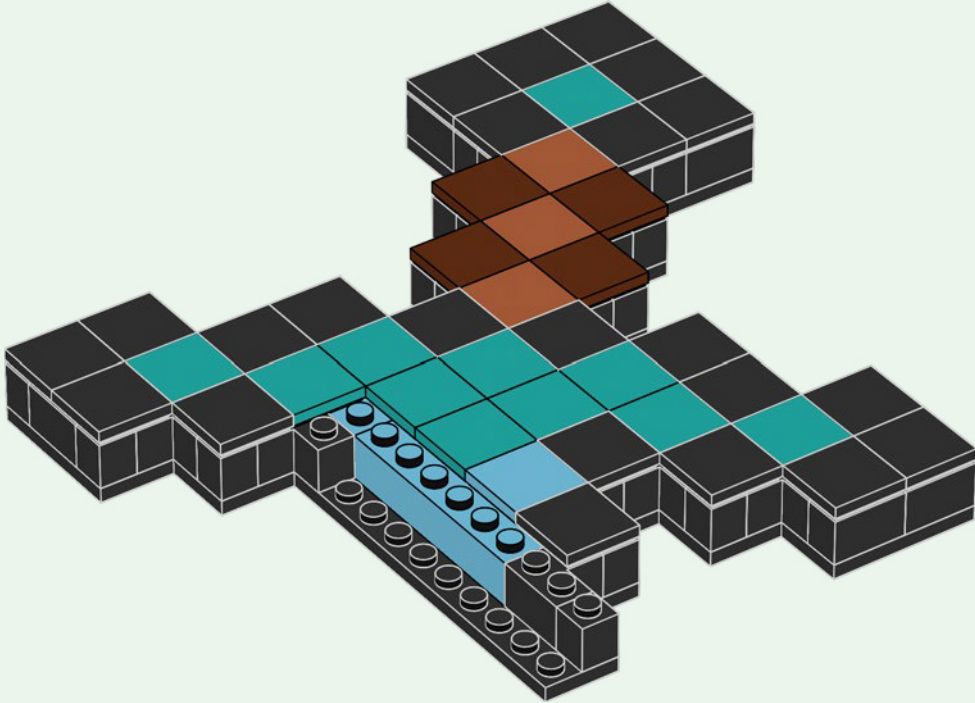

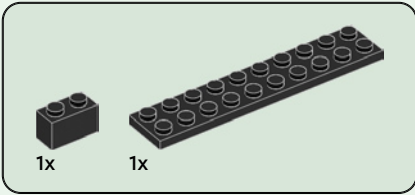
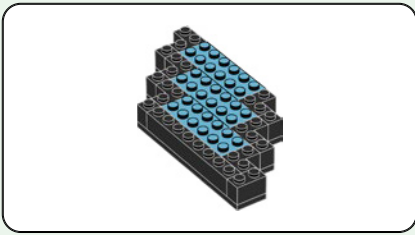

65

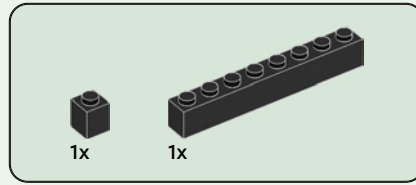
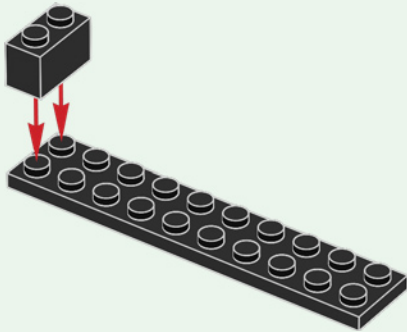

66

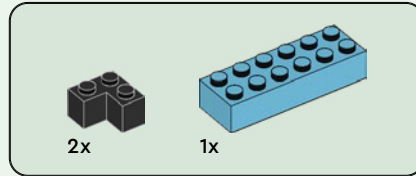
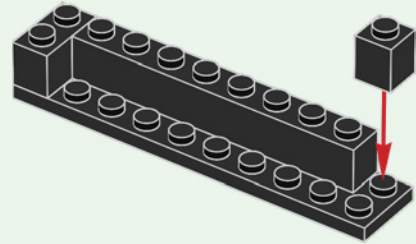

67

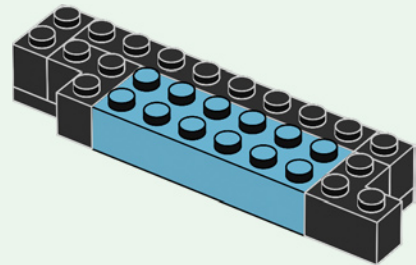

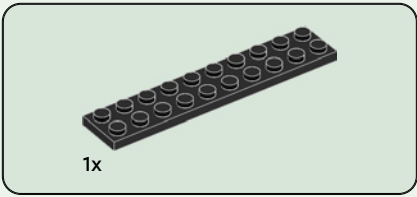

68

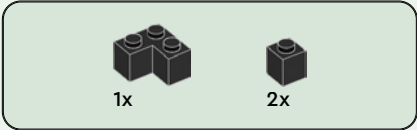
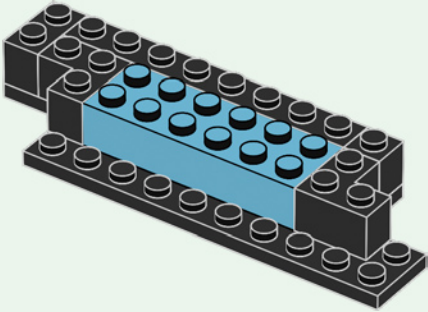

69

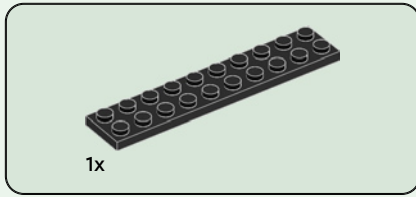
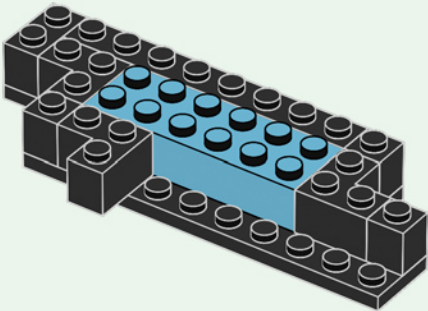

70

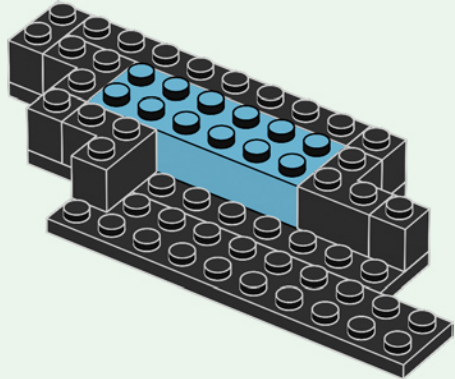

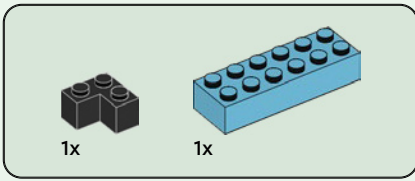

71

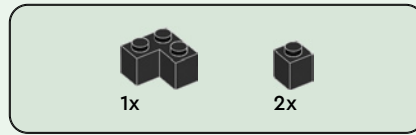
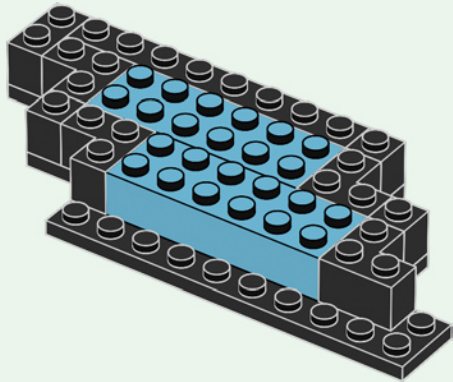

72

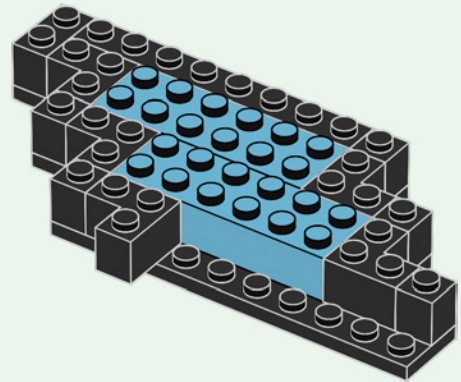

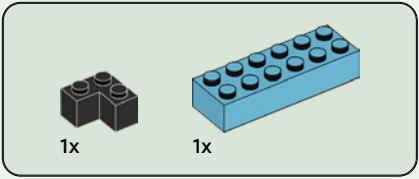

73

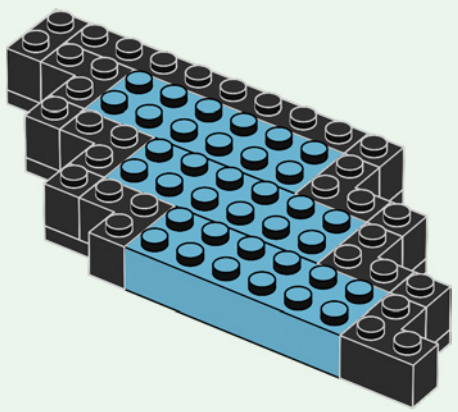

74

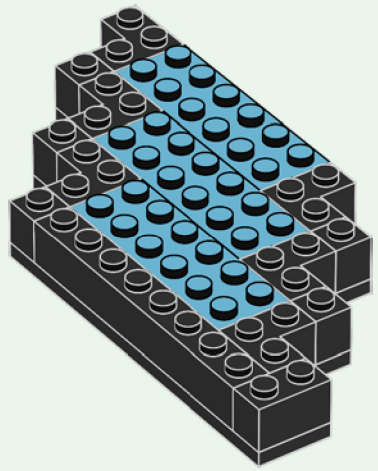

75

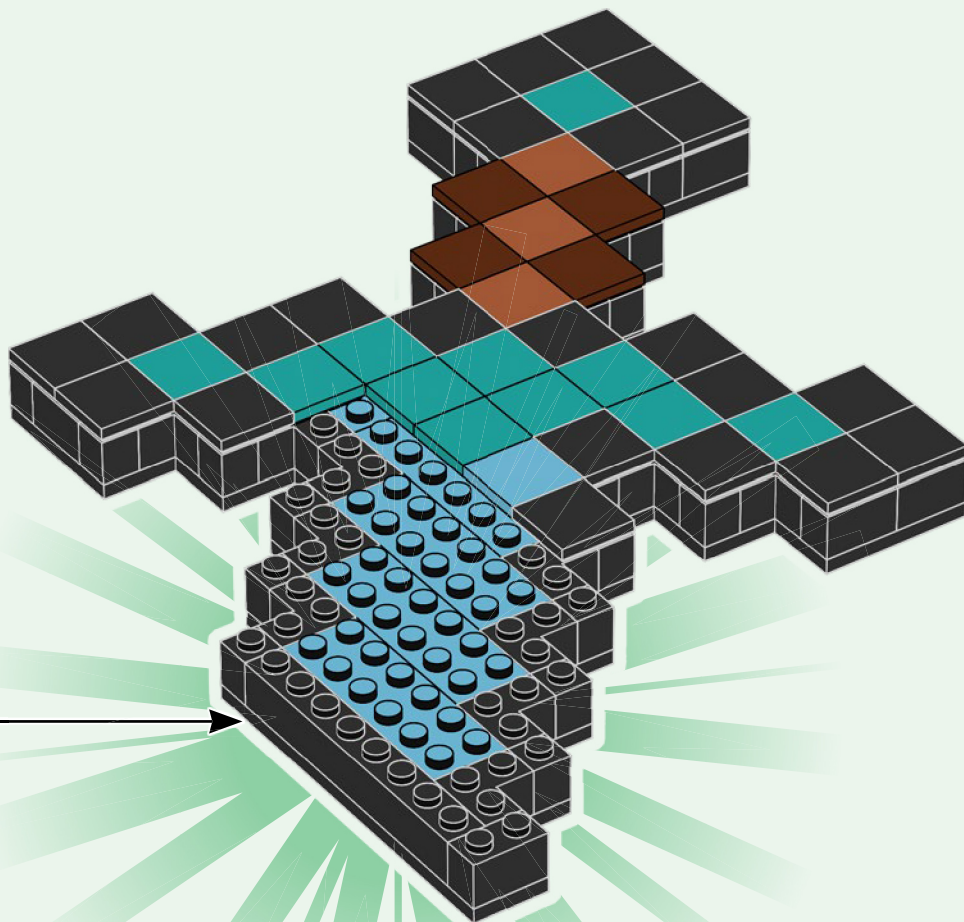

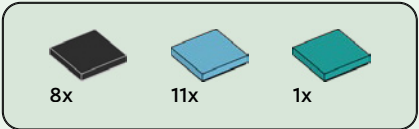

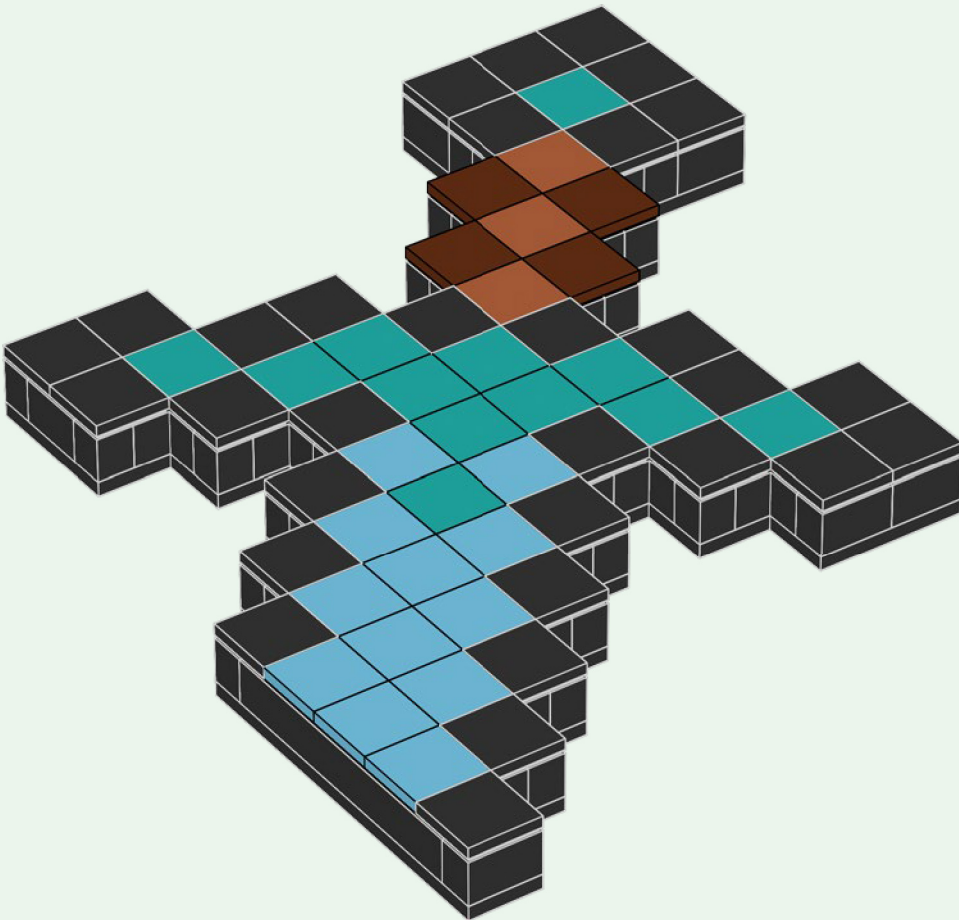

76

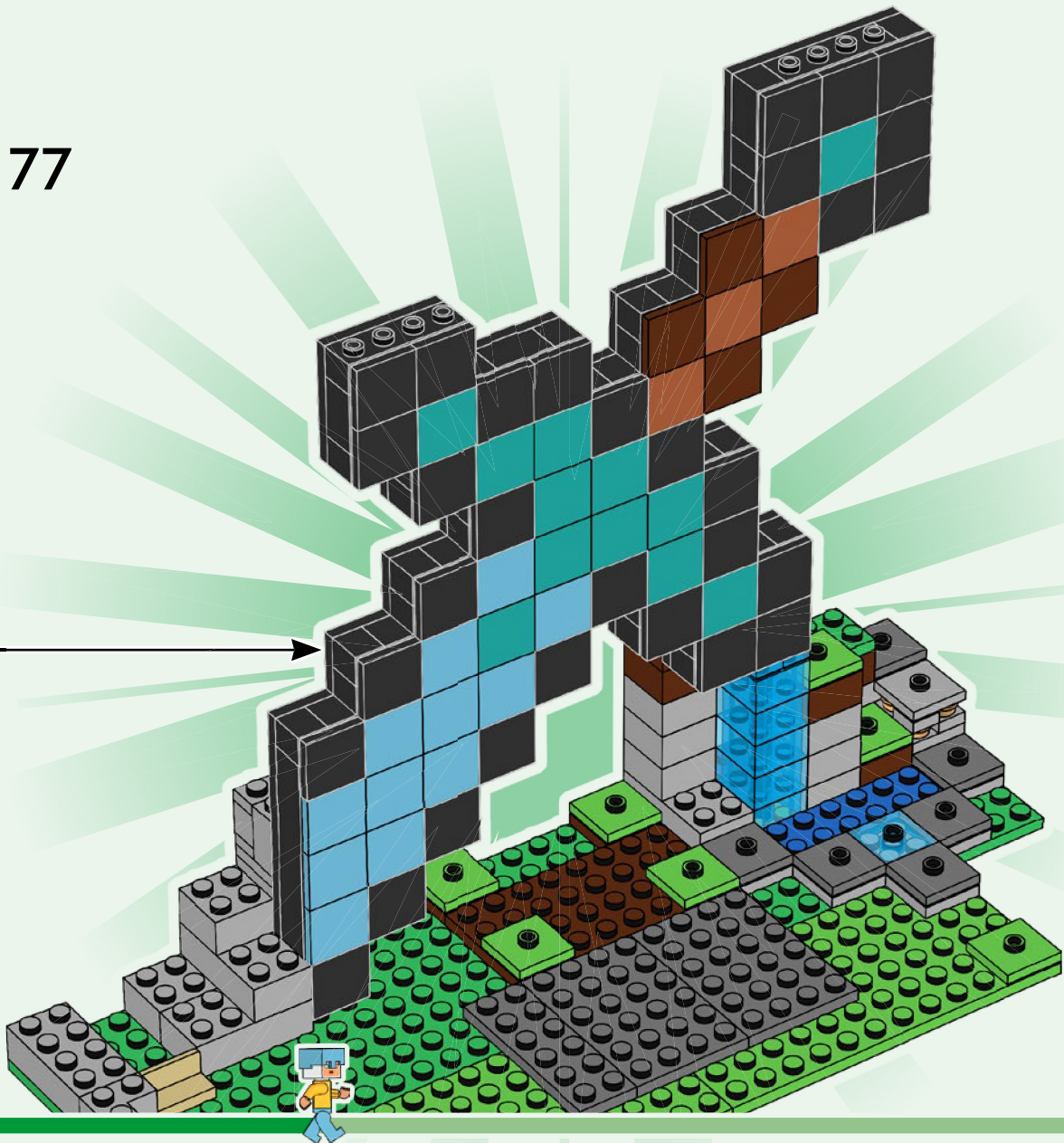

77





3x  1x 

78

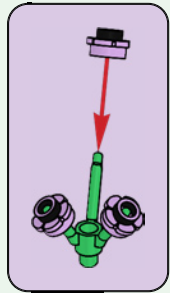
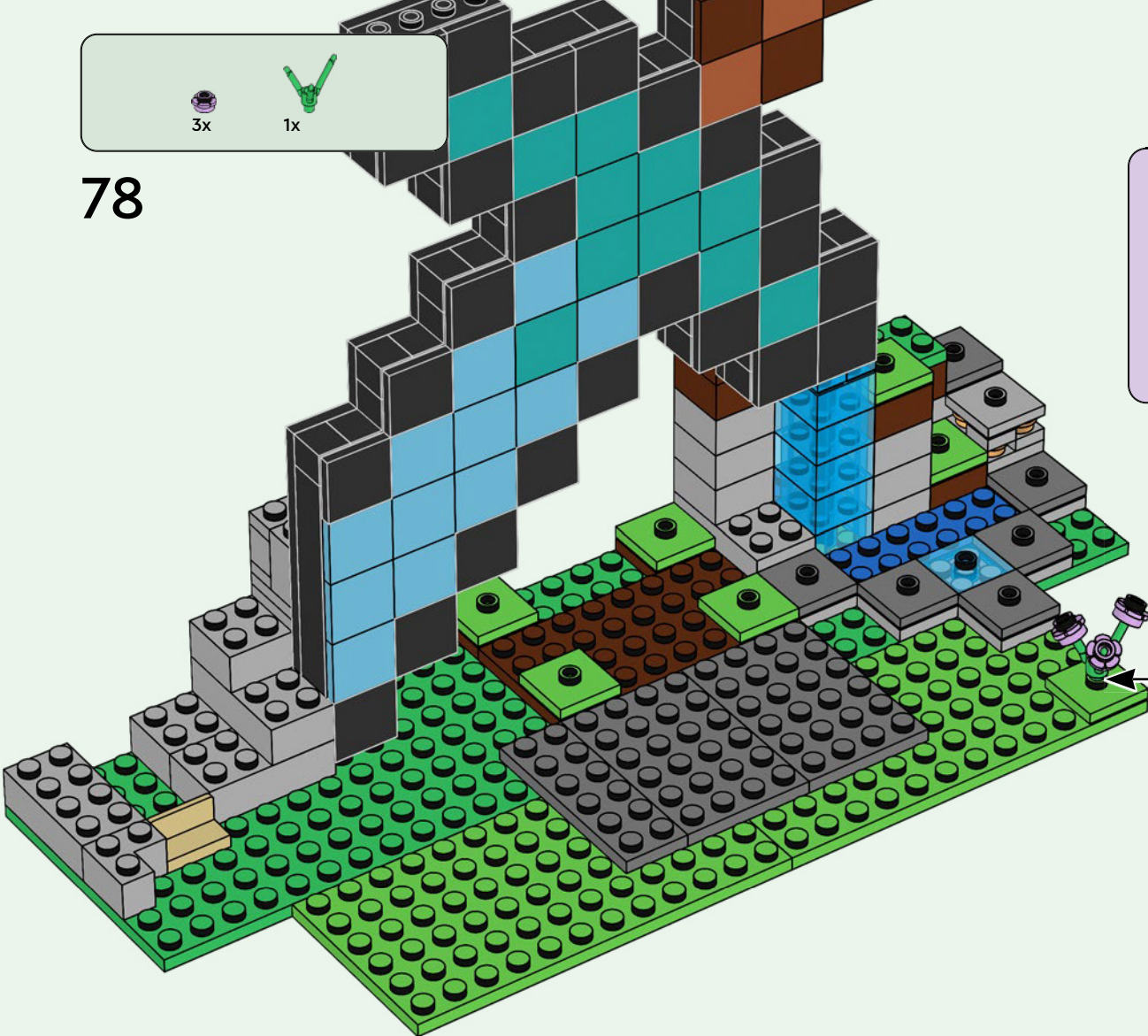

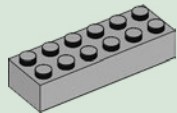

1x

79

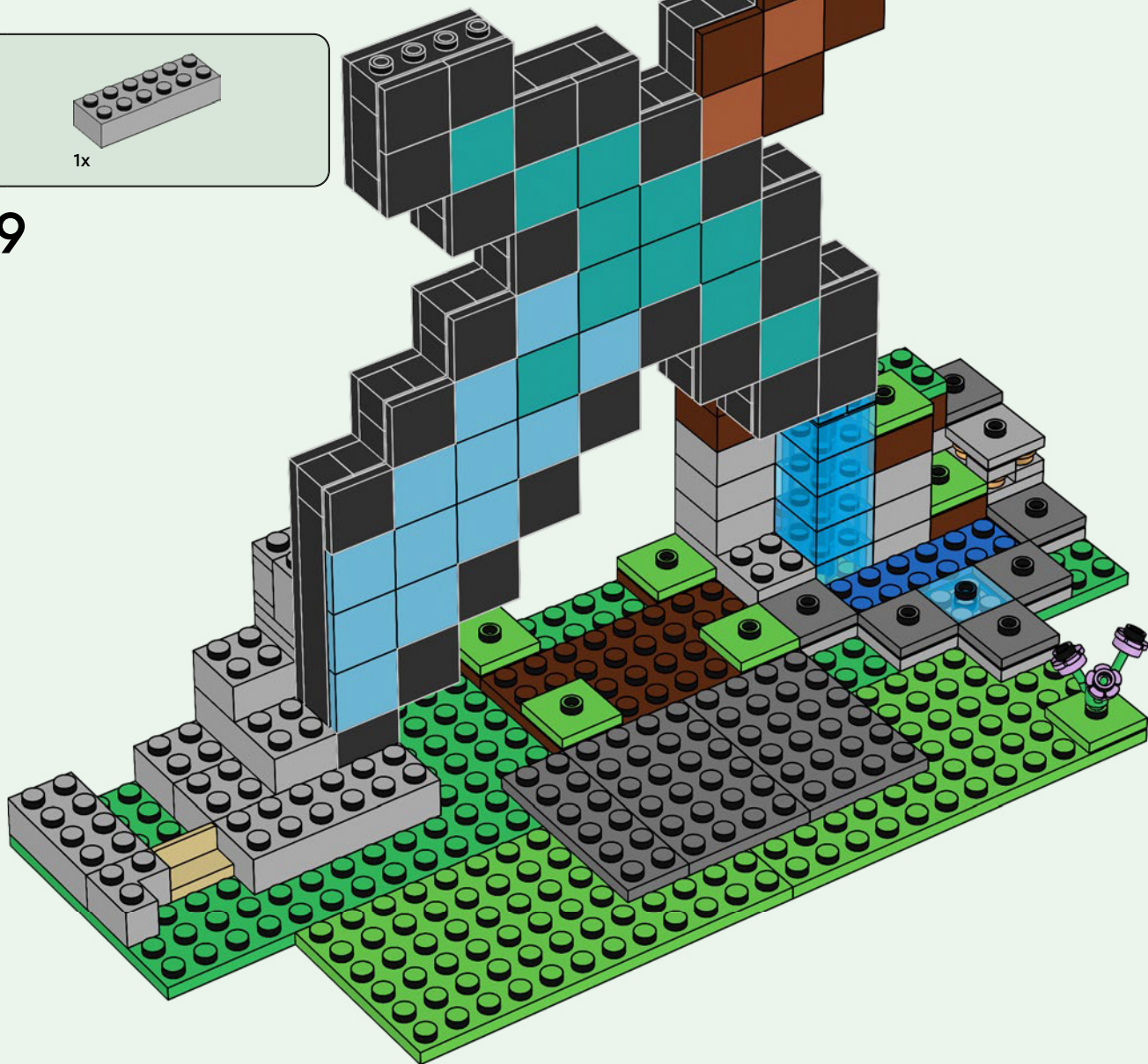

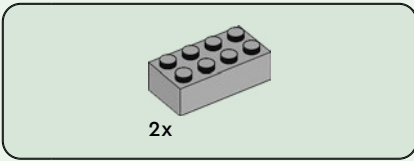

80

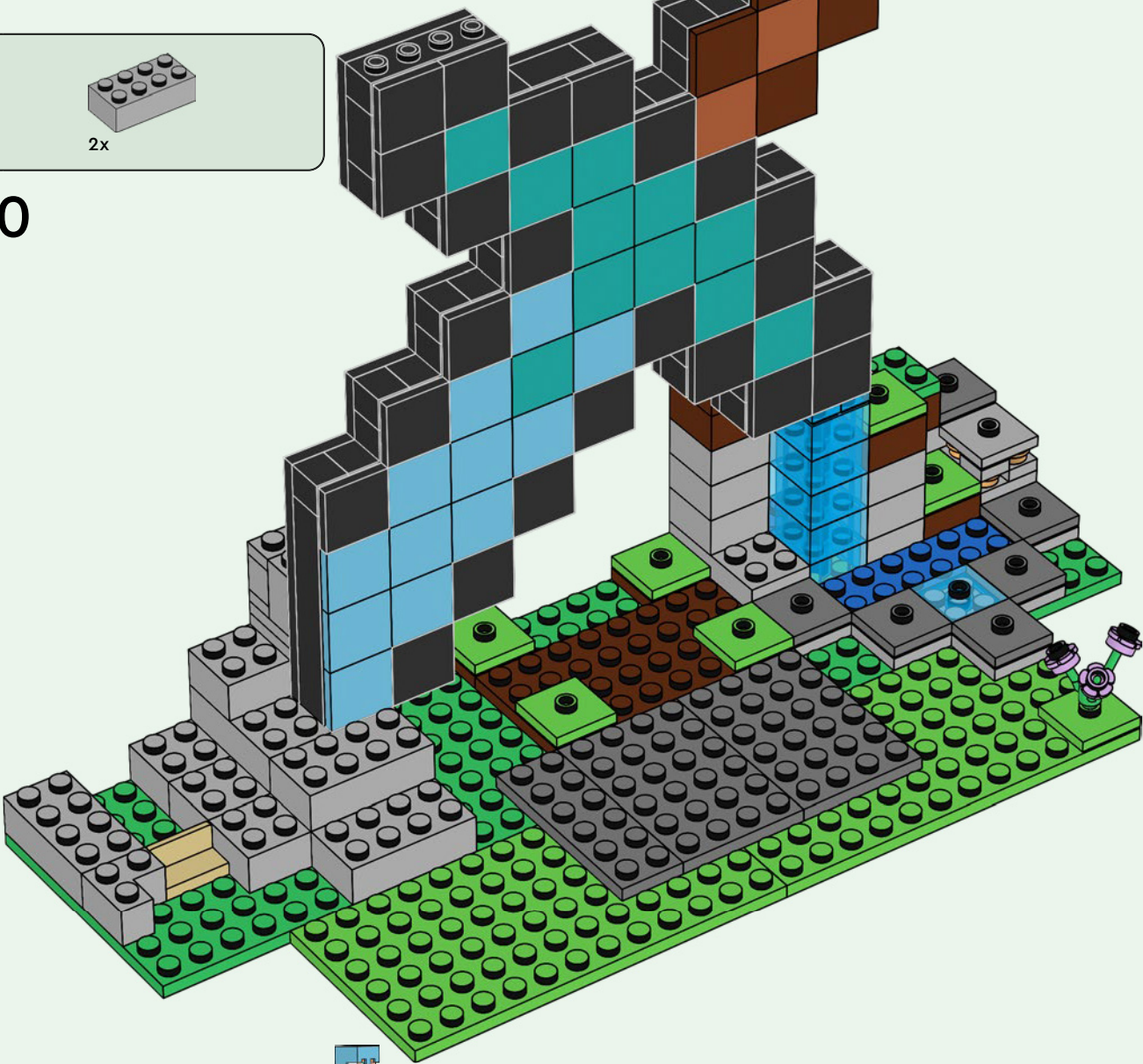

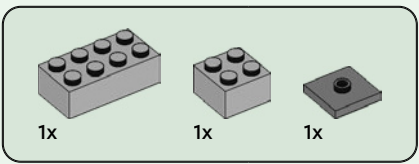

81

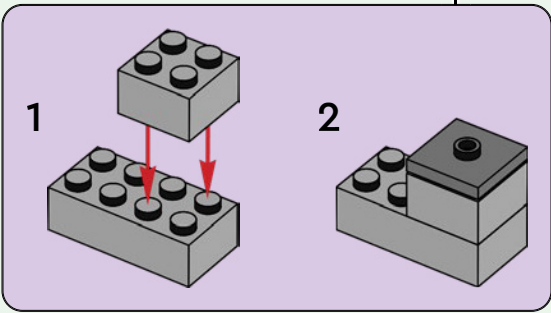
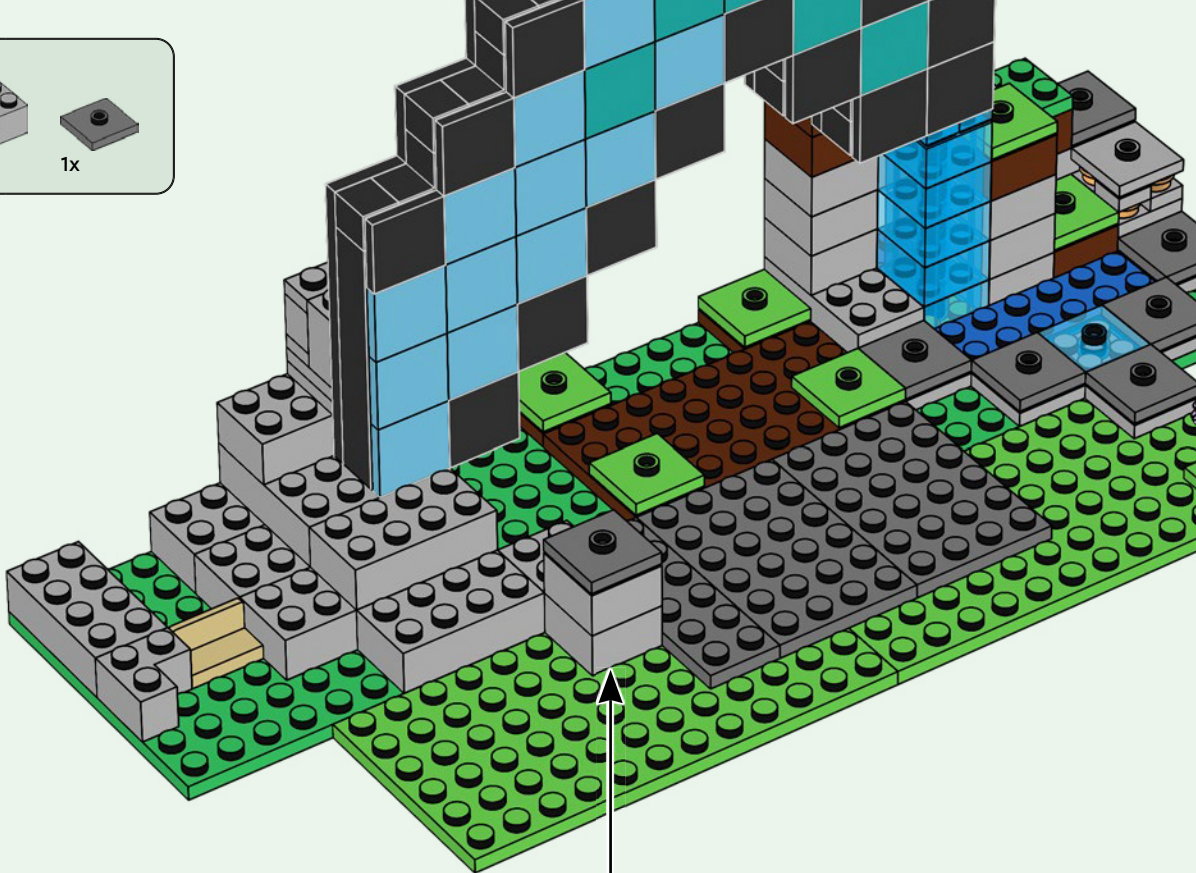

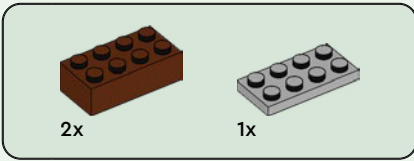

82

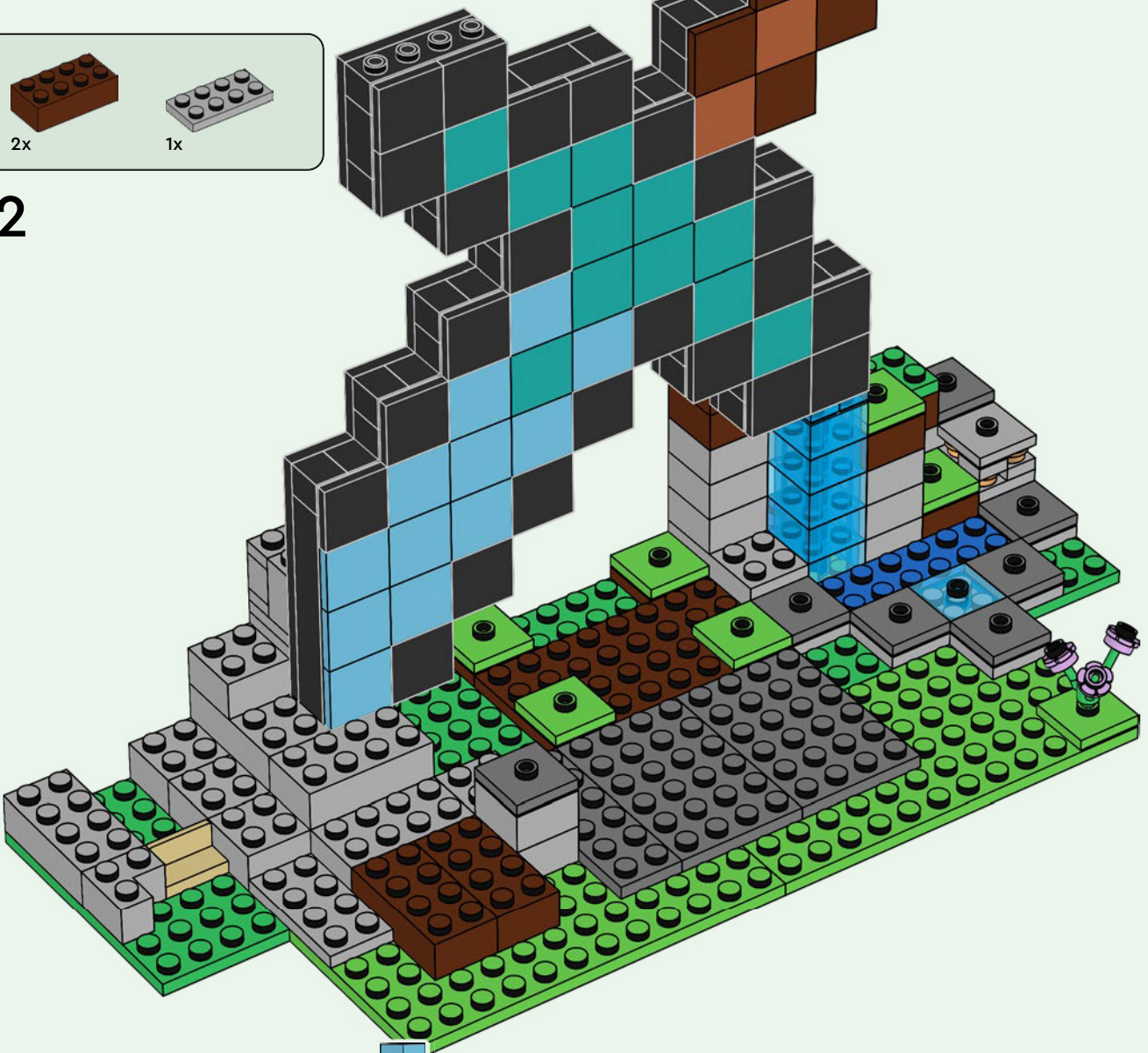

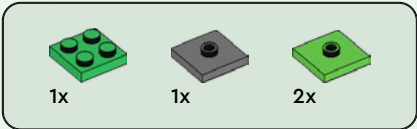

83

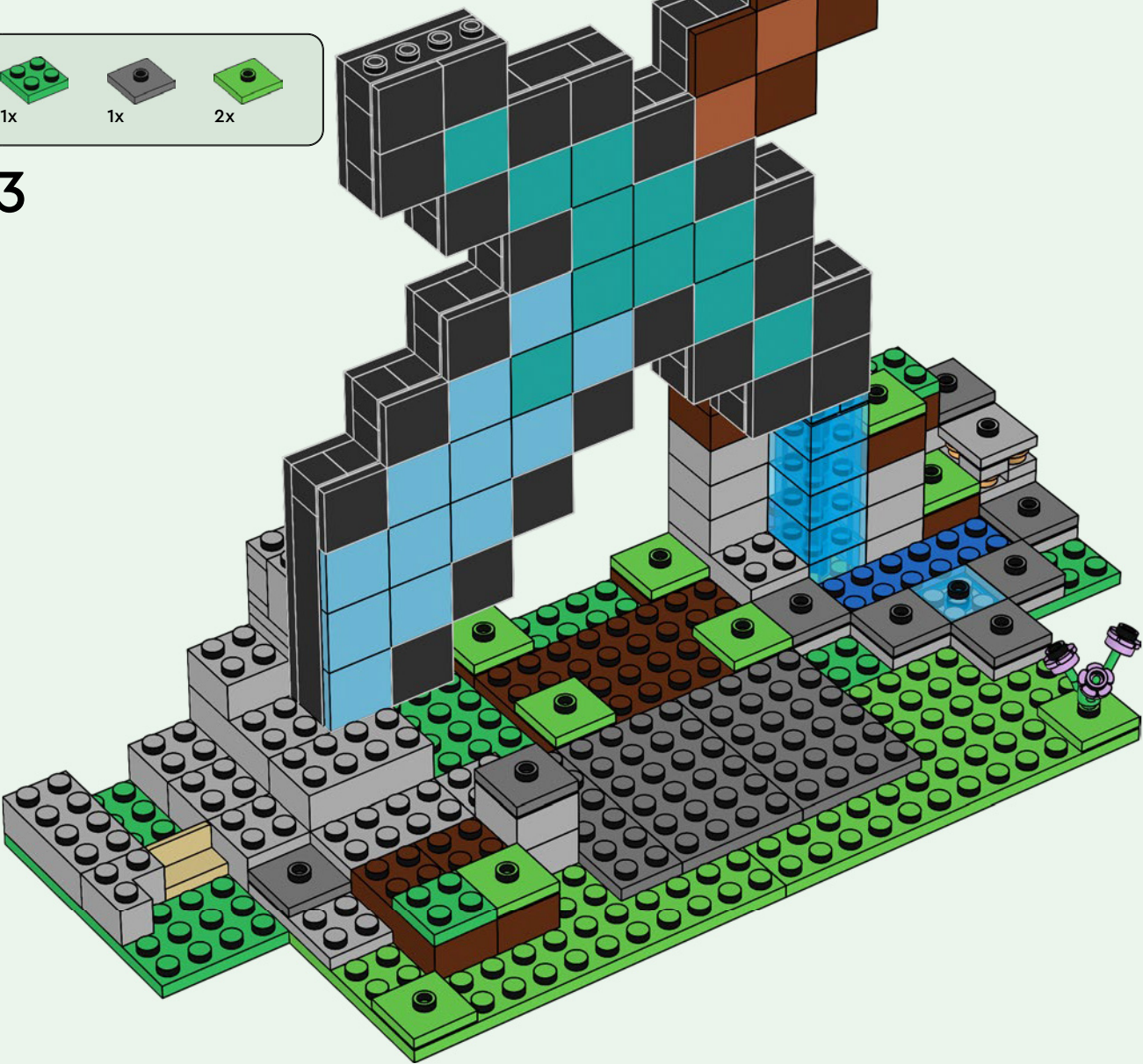

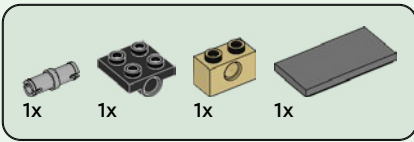

84

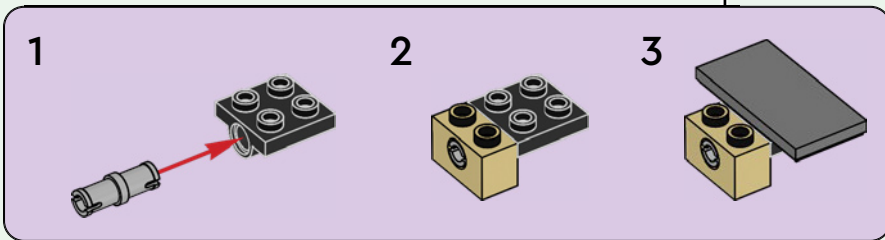
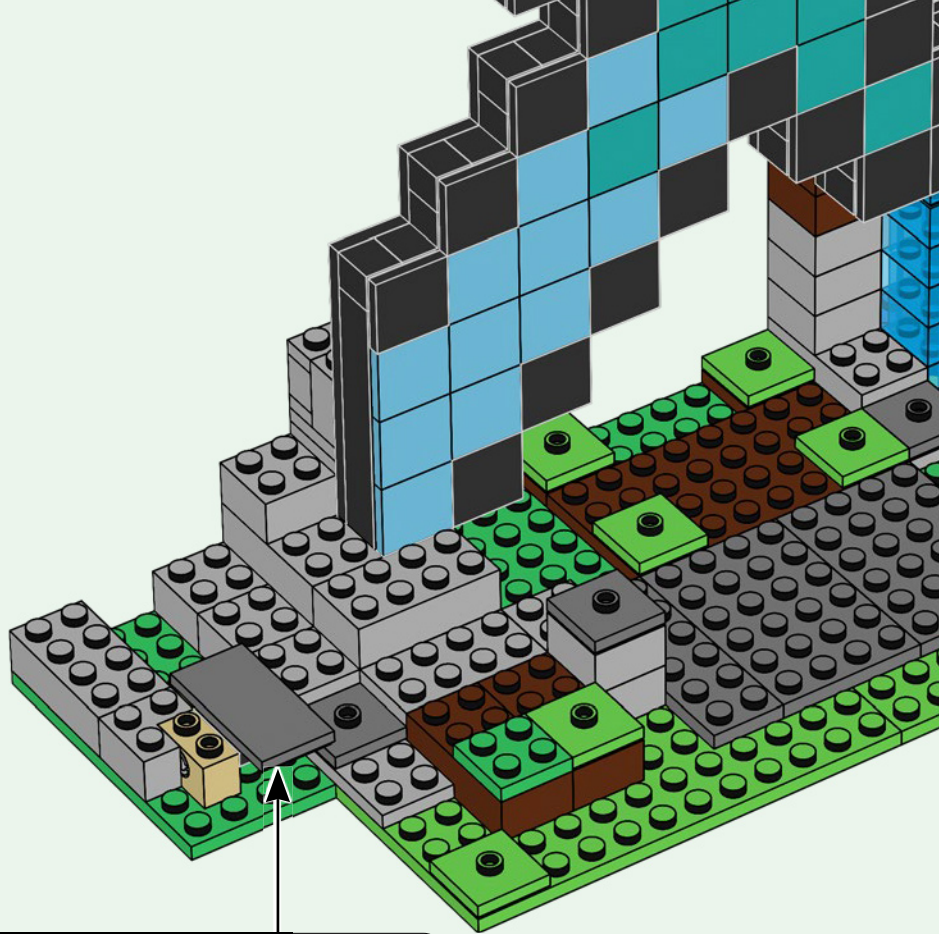



1x

85

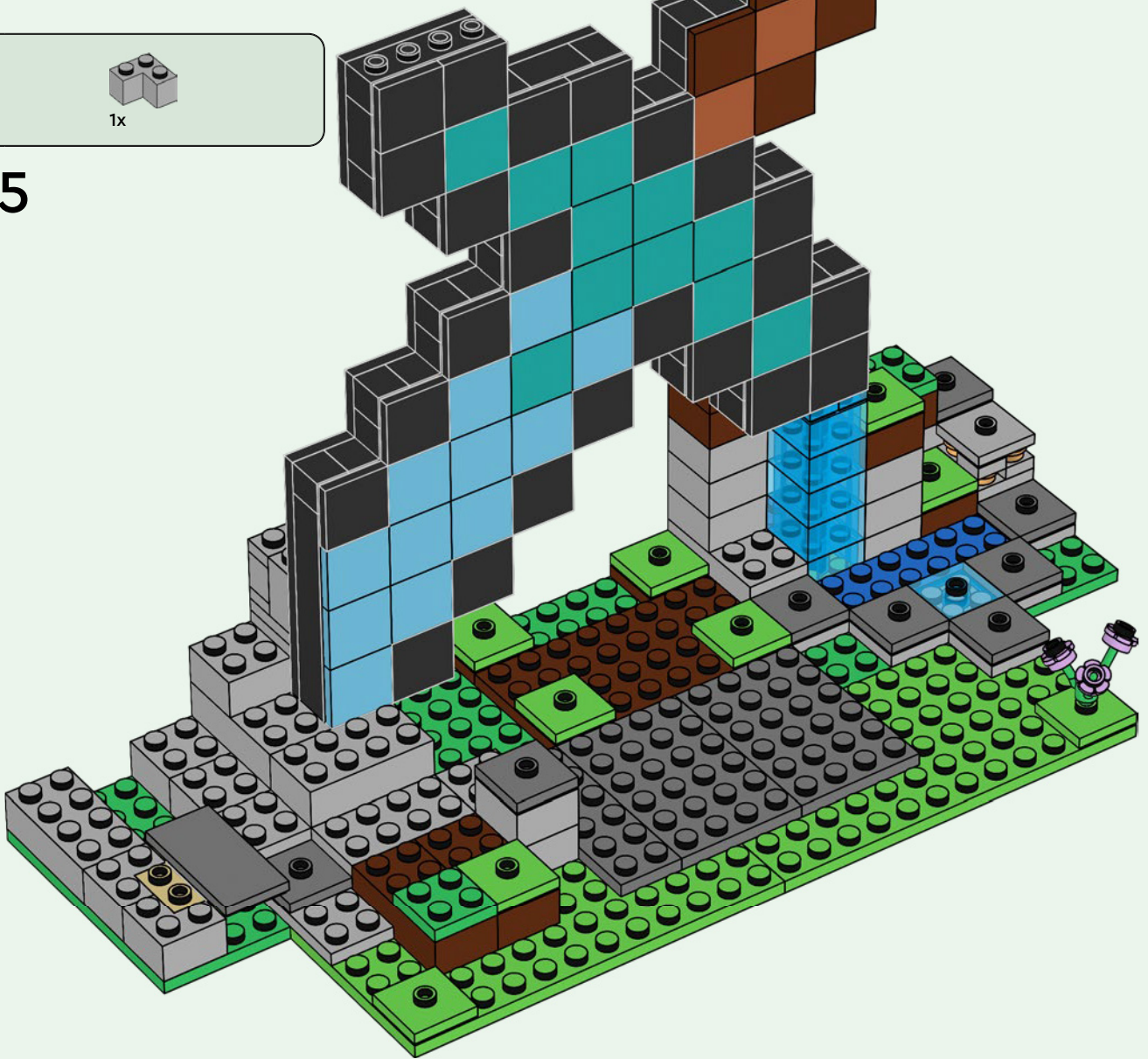

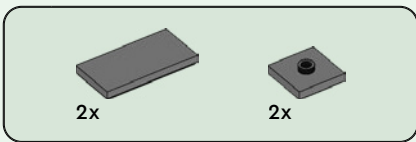

86

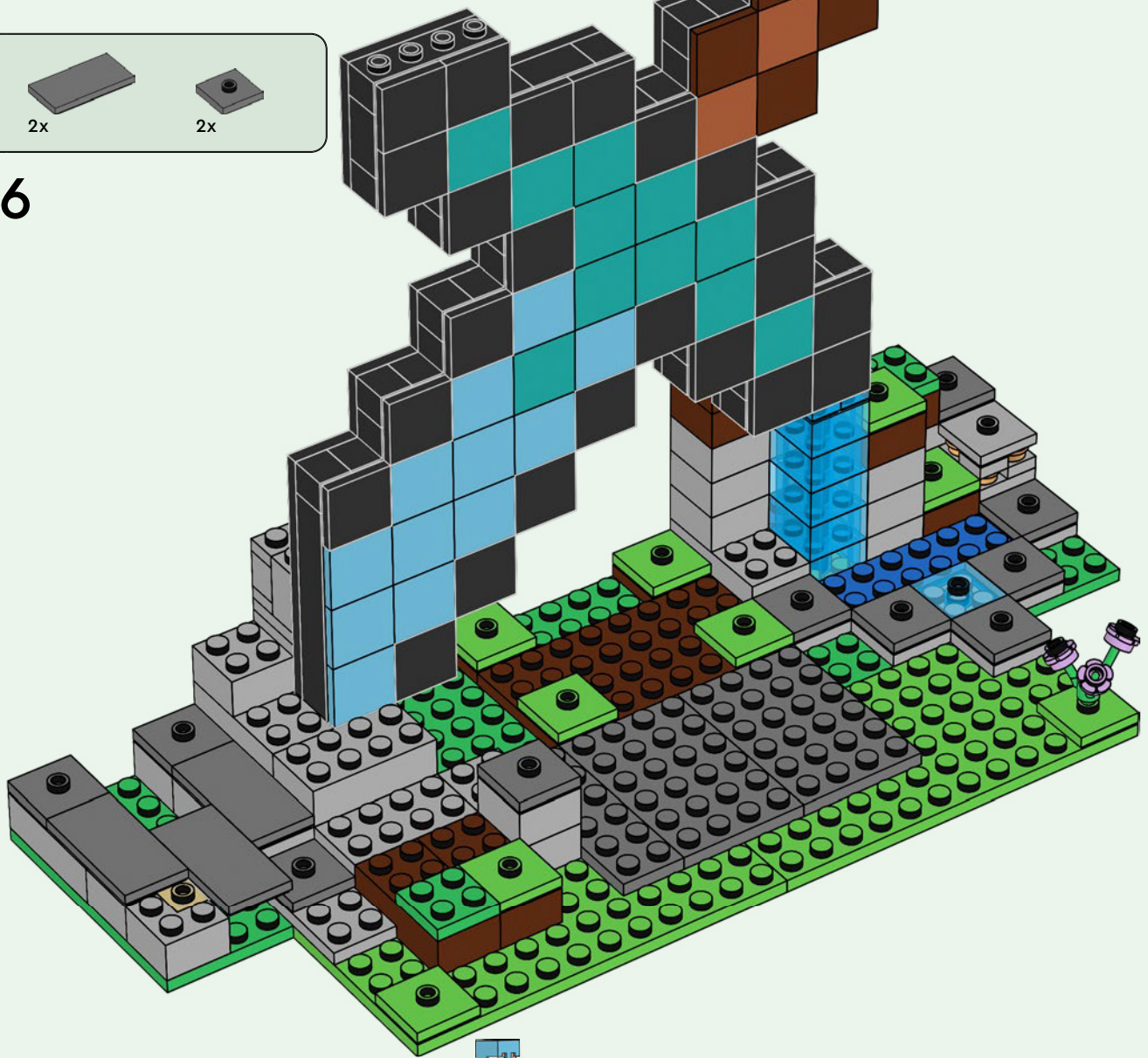

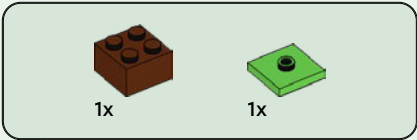

87

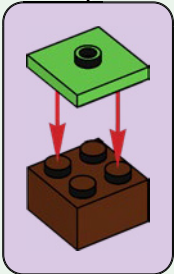
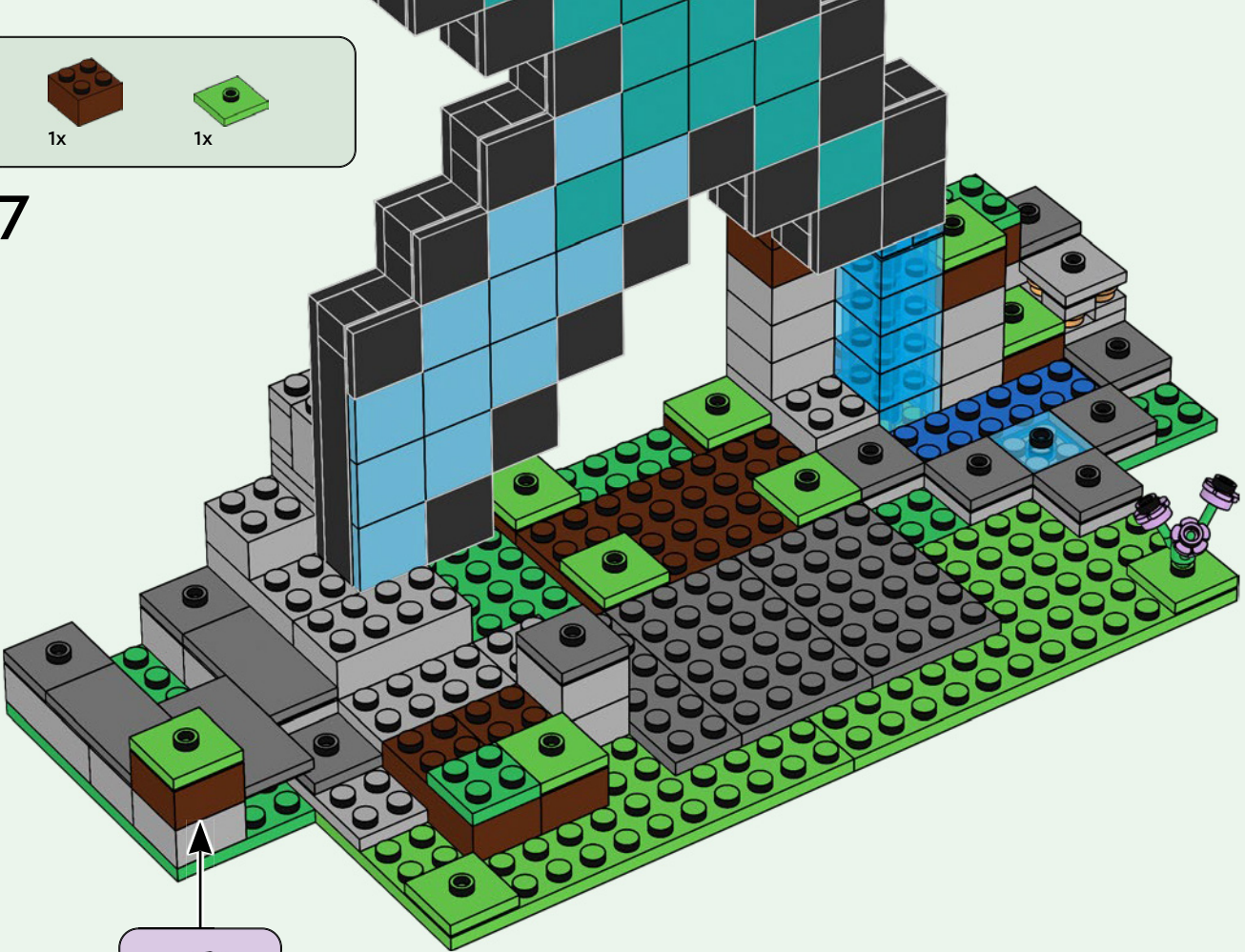

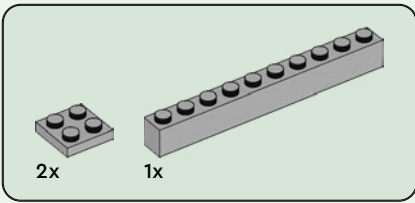

88

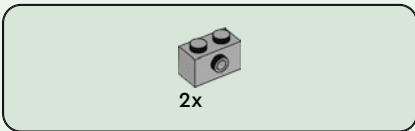
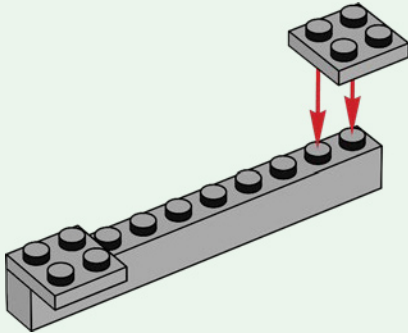

89

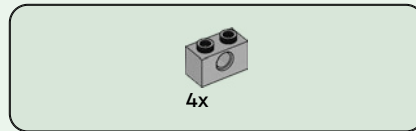
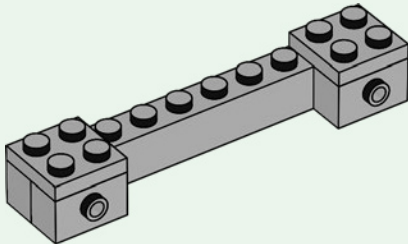

90

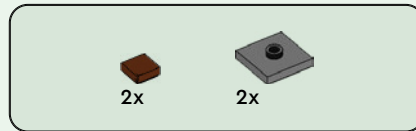
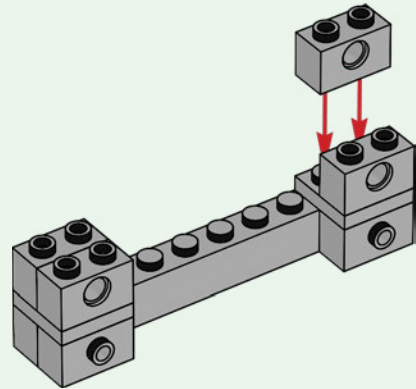

91

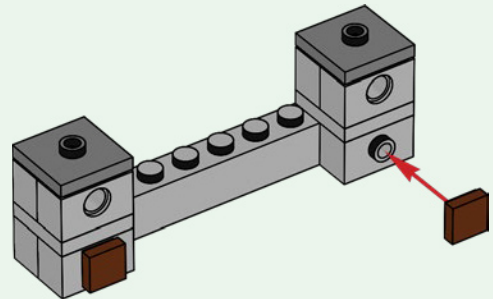

92

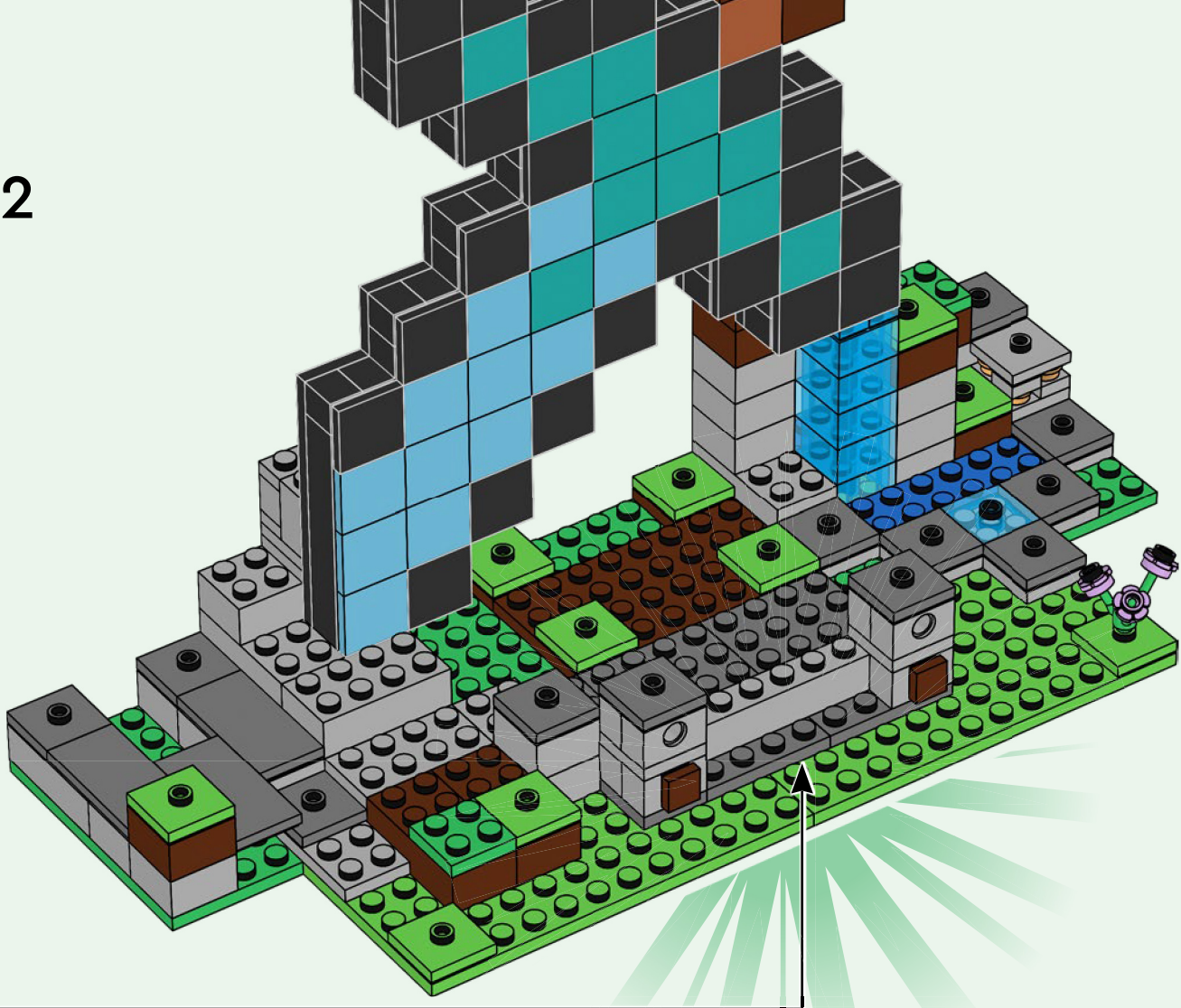



2x

93

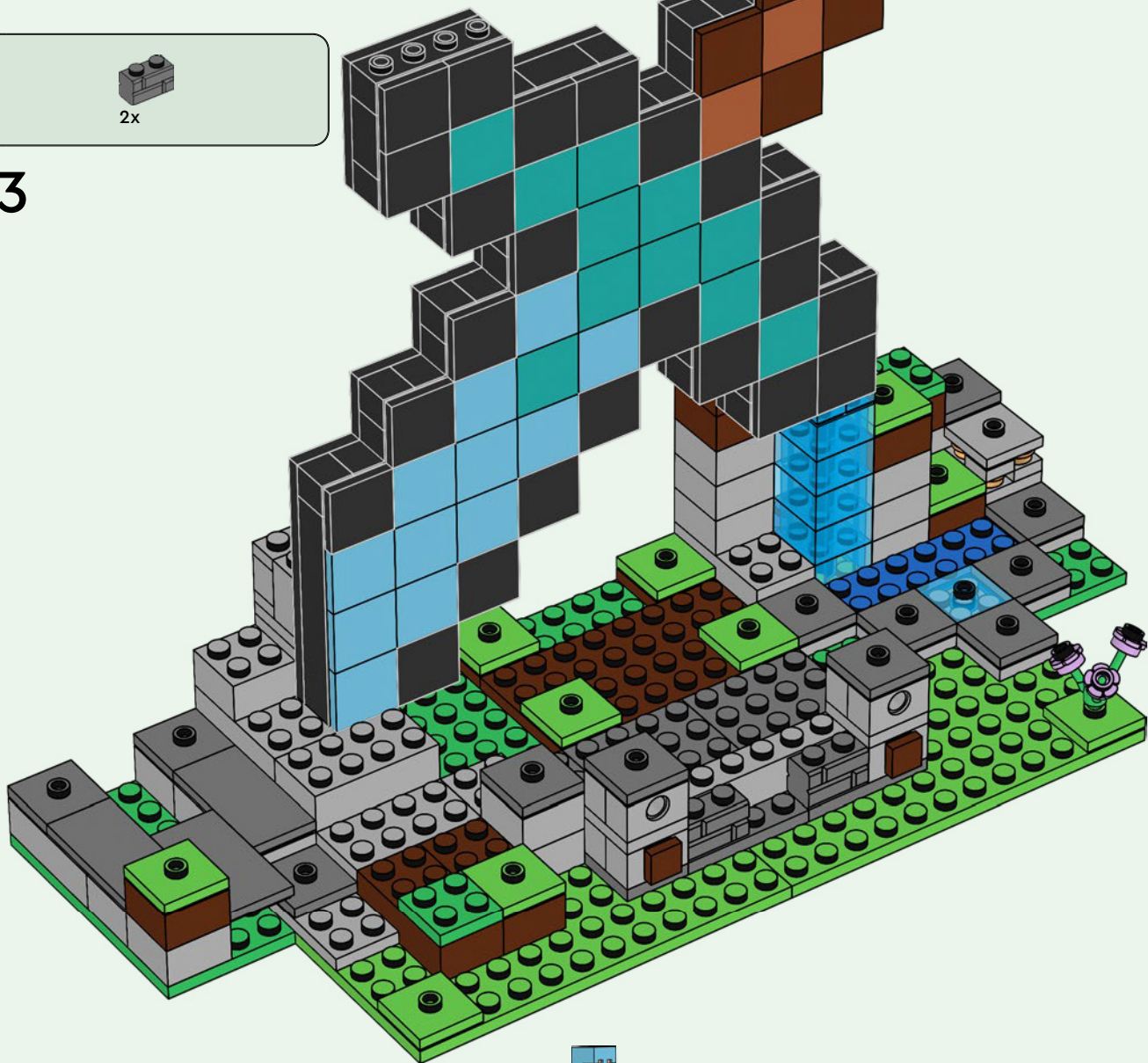

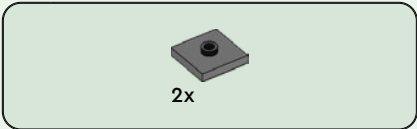

94

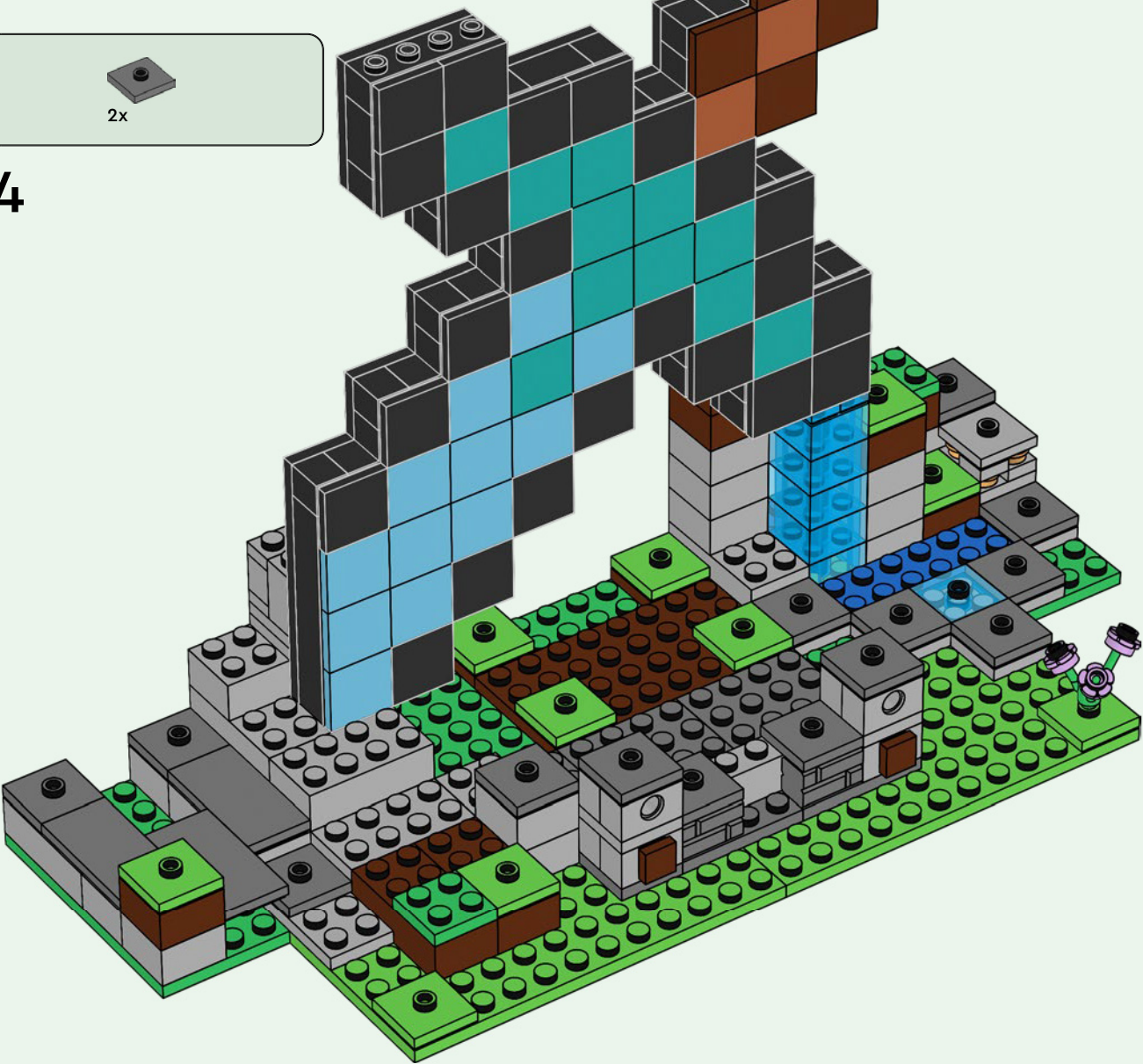

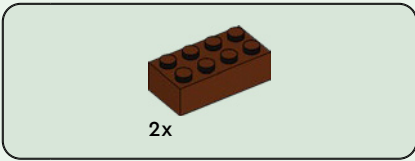

95

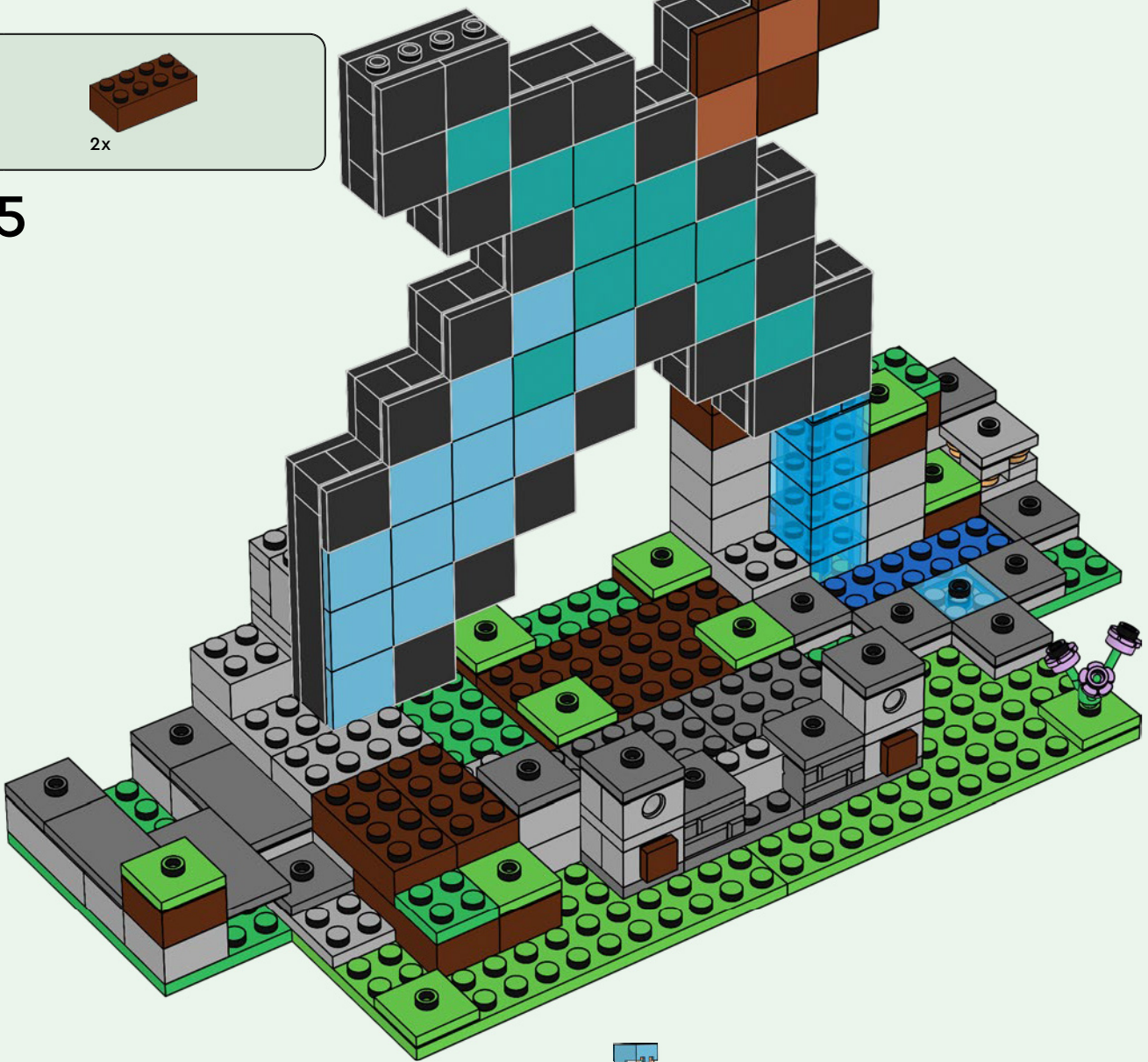

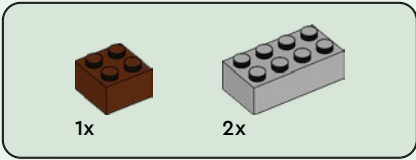

96

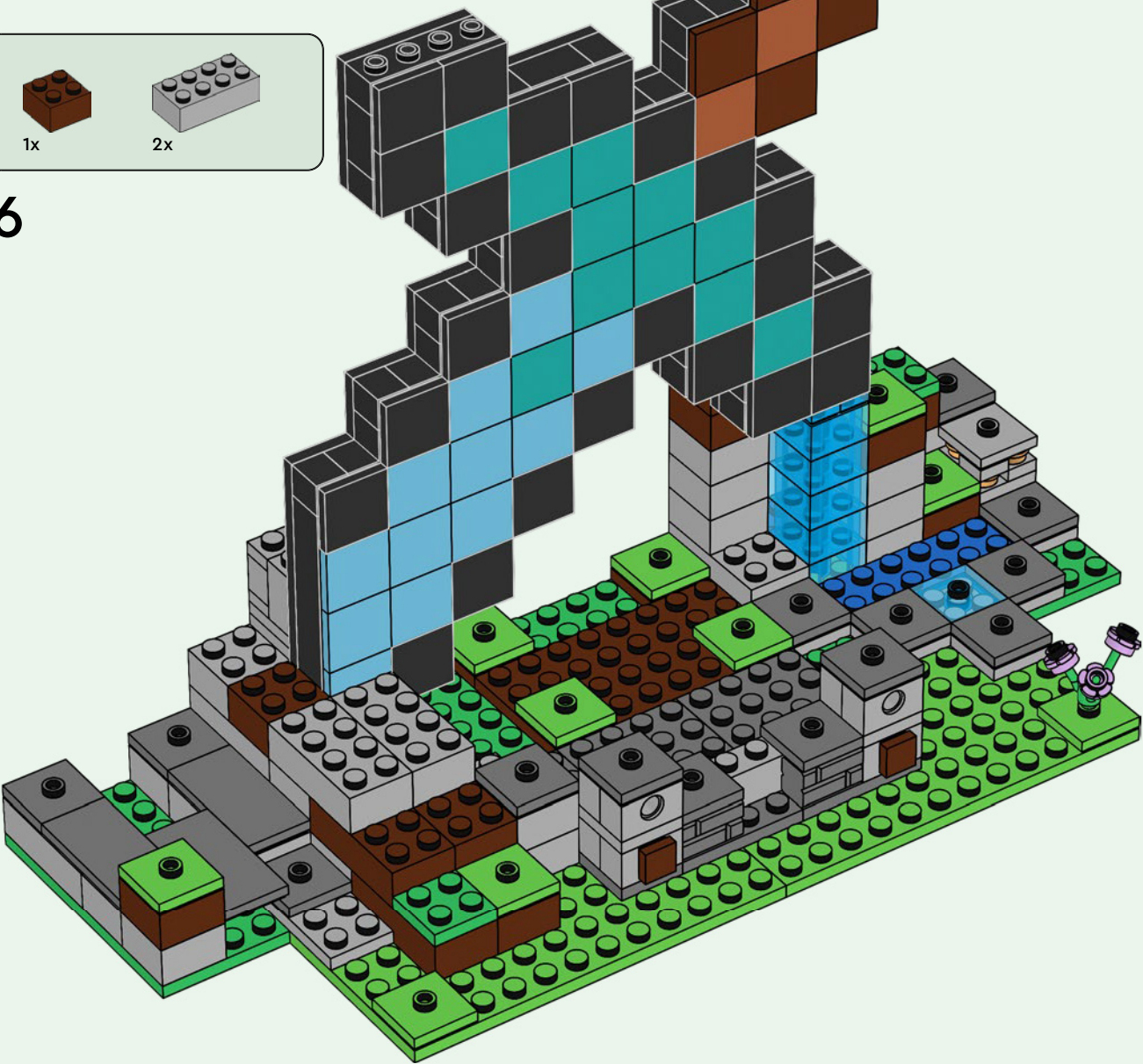

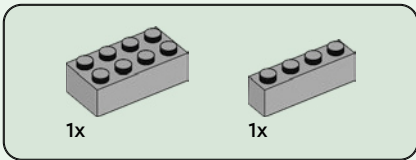

97

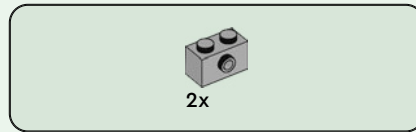
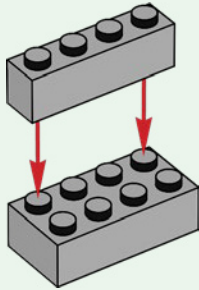

98

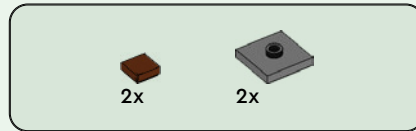
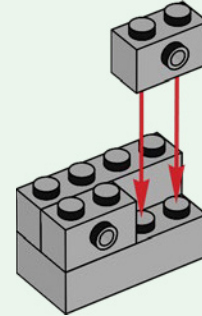

99

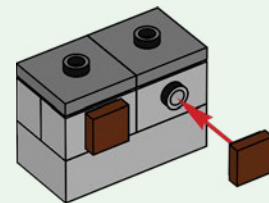

100

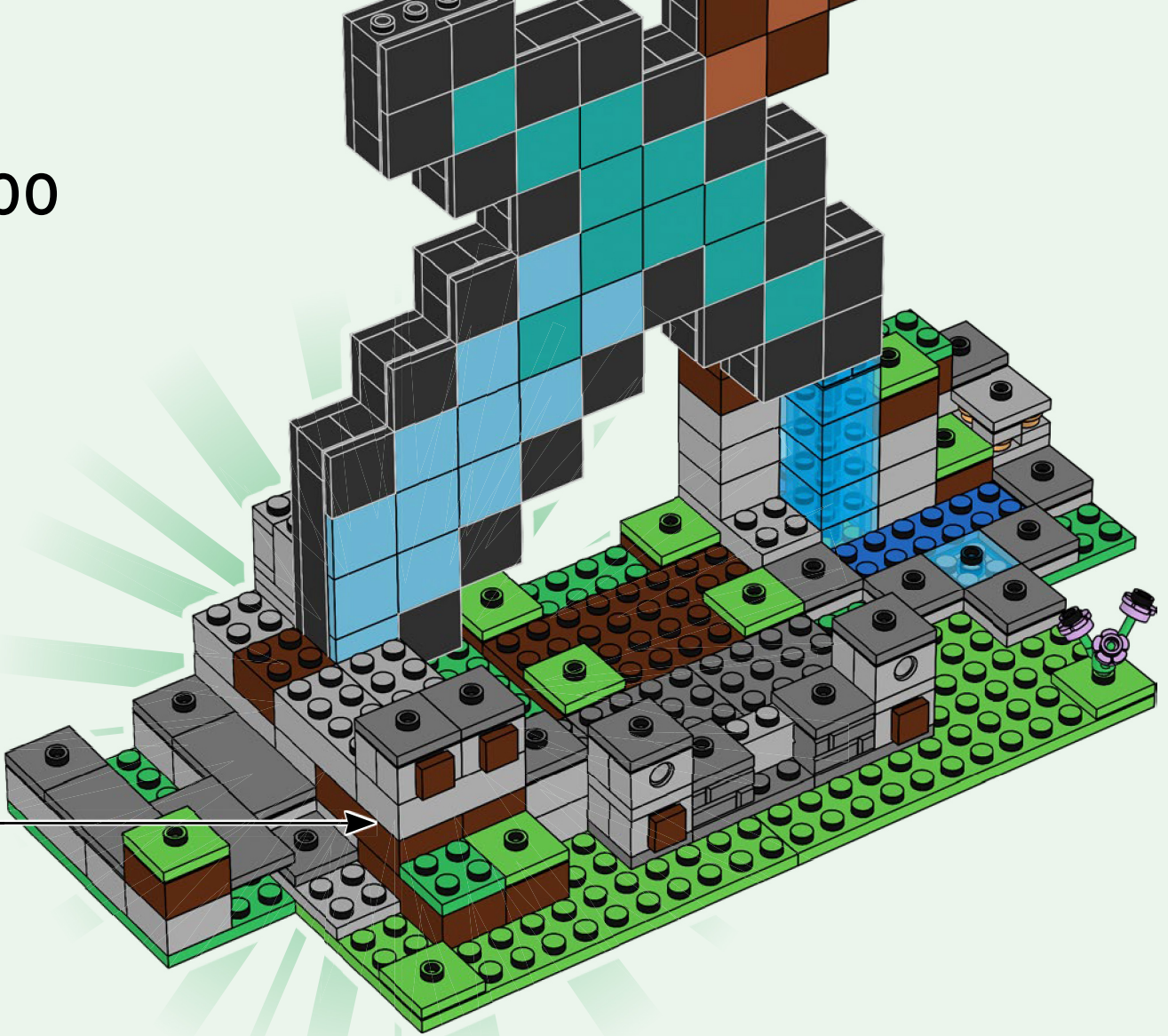

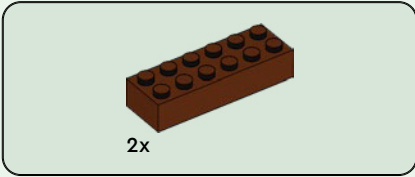
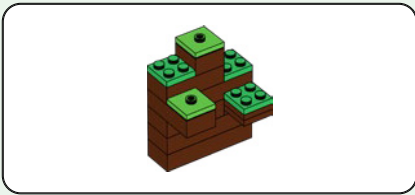

101

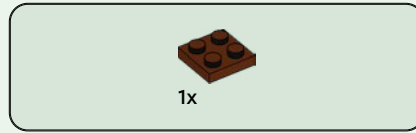
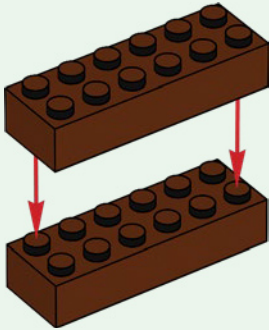

102

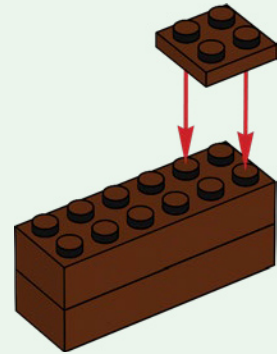

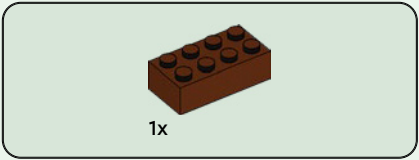

103

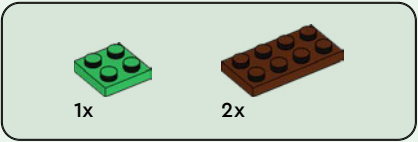
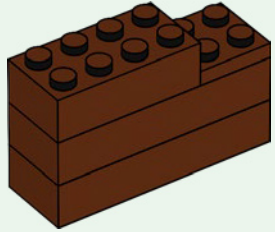

104

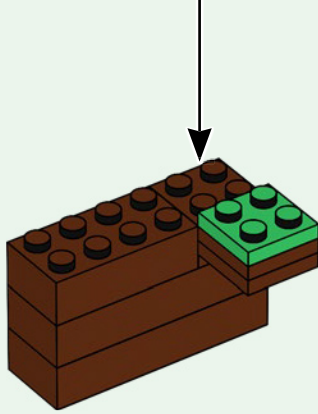
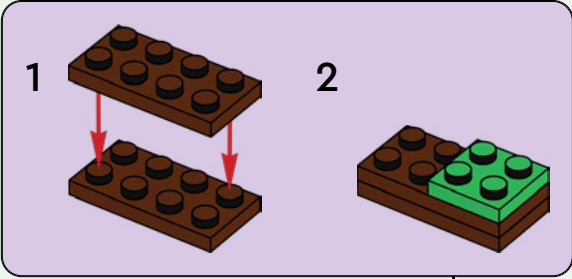

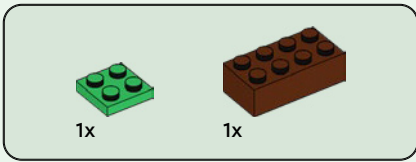

105

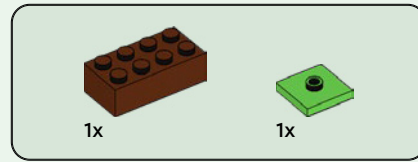
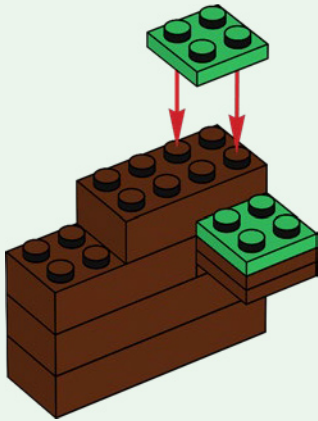

106

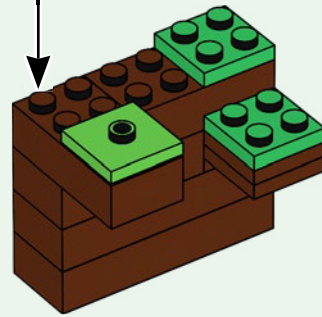
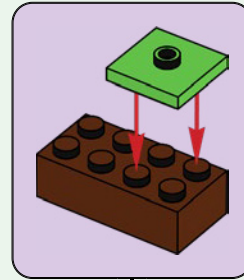

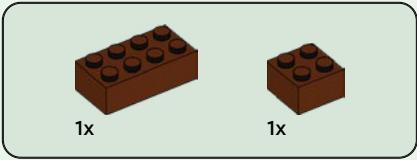

107

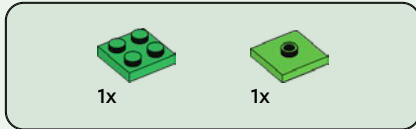
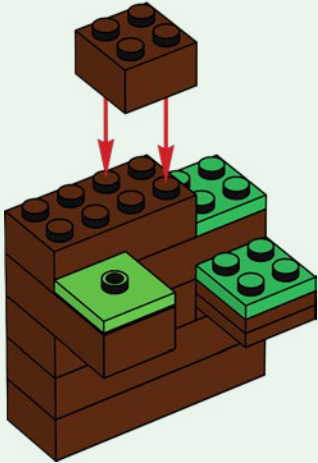

108

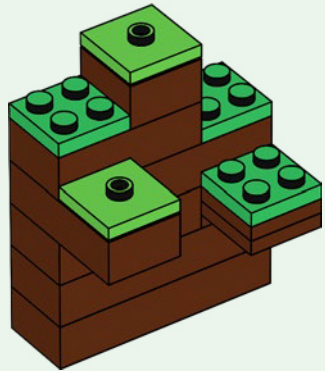

109

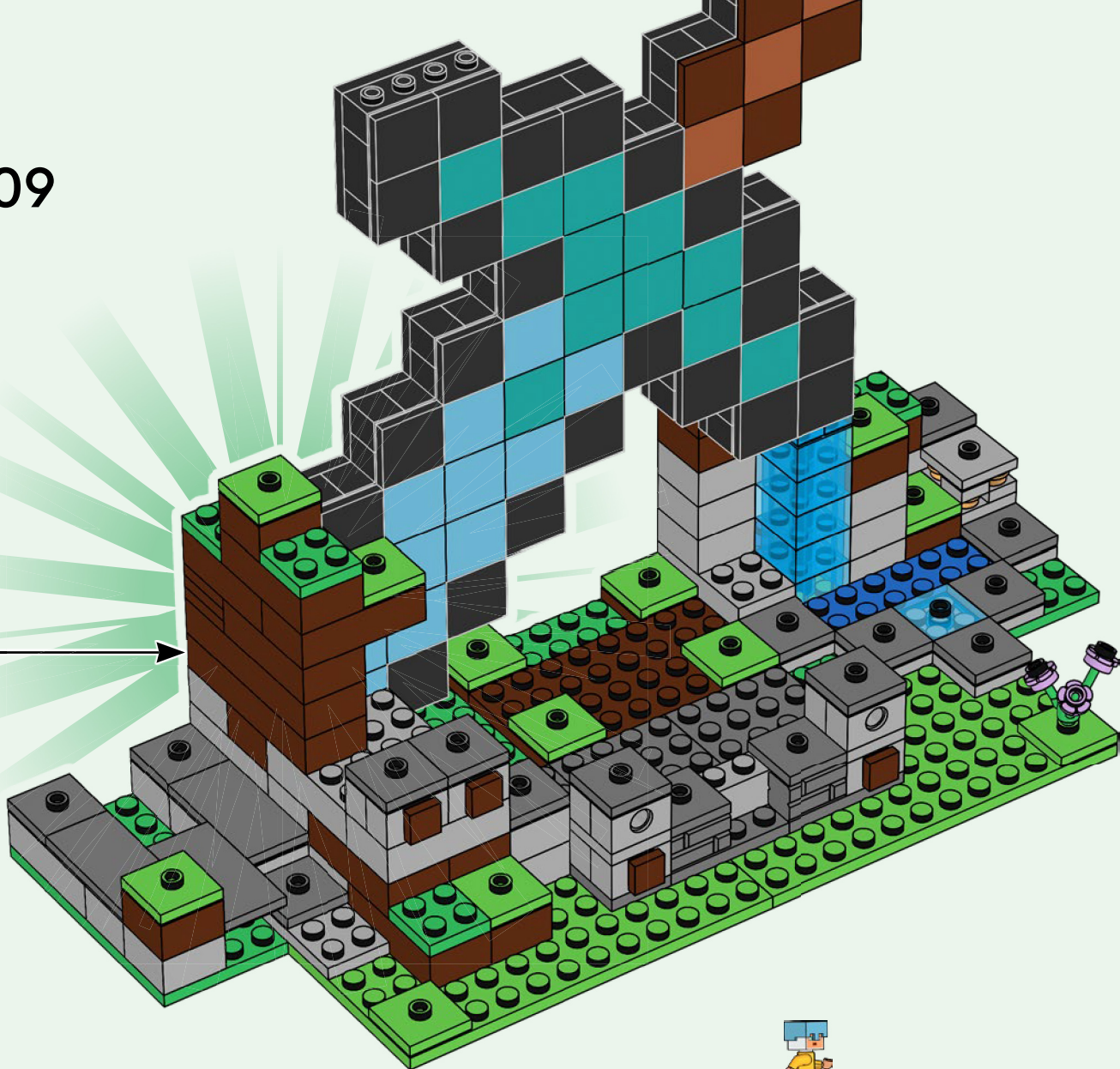

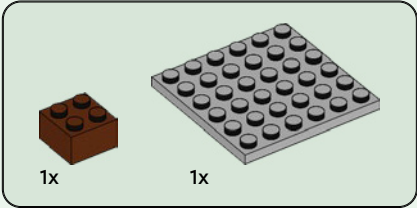
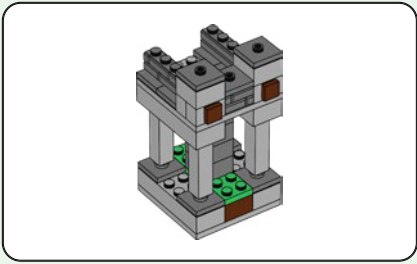

110

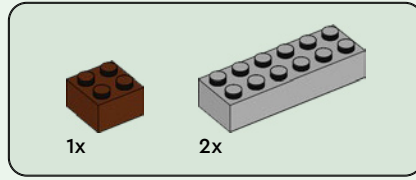
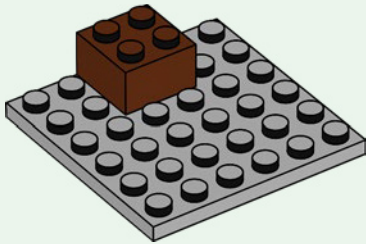

111

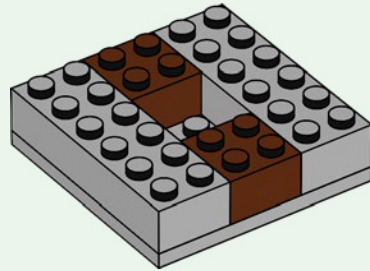

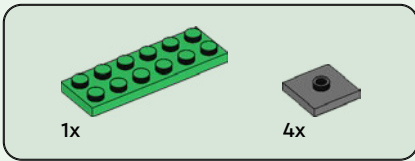

112

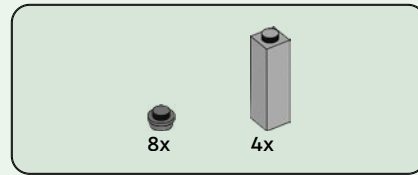
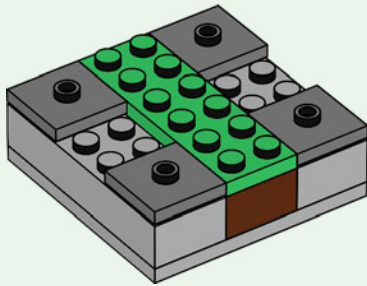

113

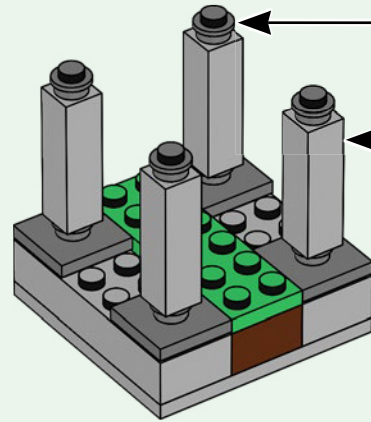
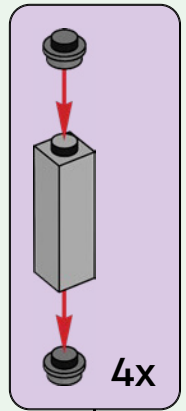



4x



2x

114

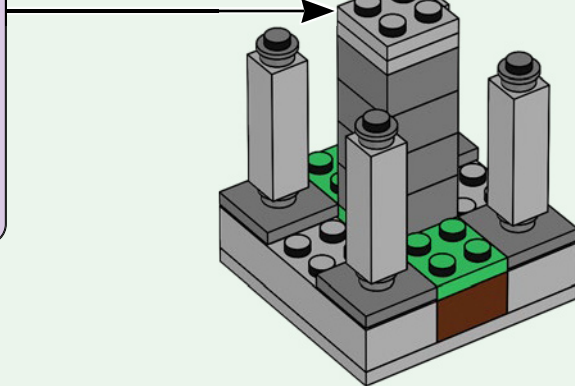
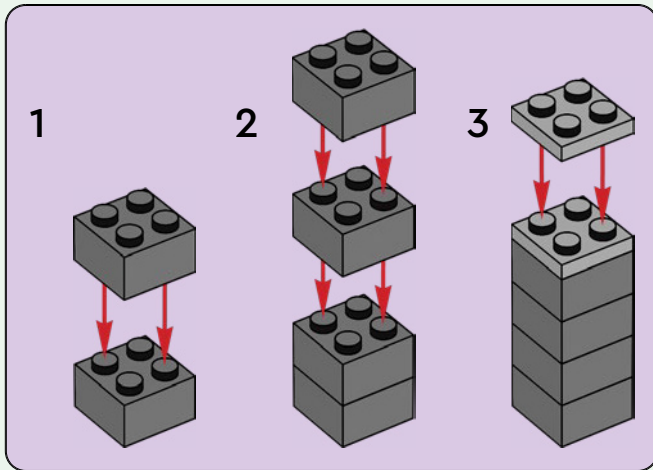

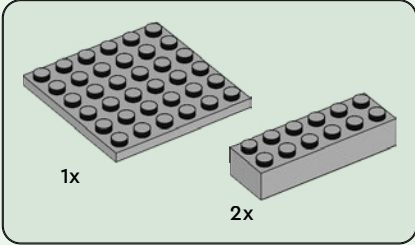
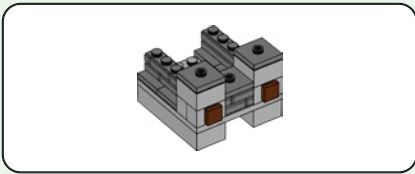

115

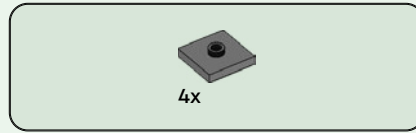
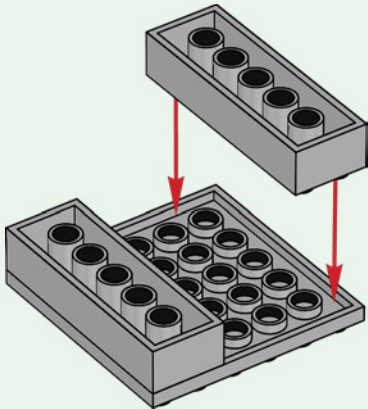

116

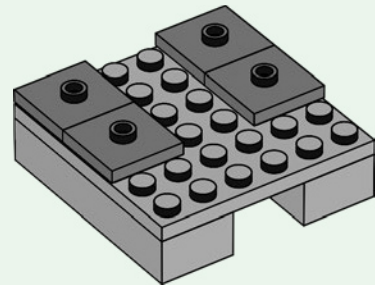
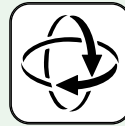

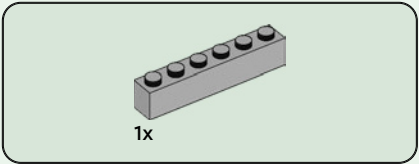

117

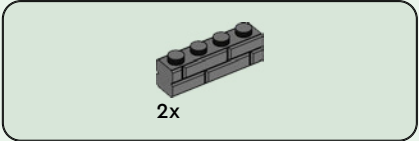
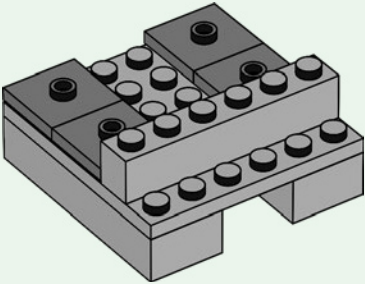

118

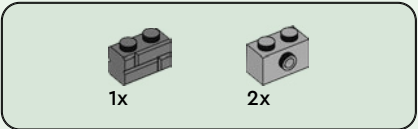
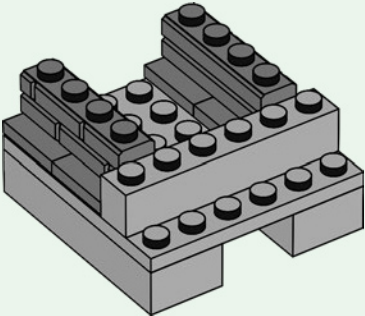

119

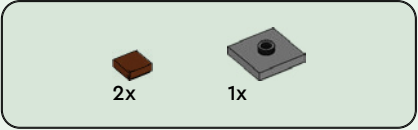
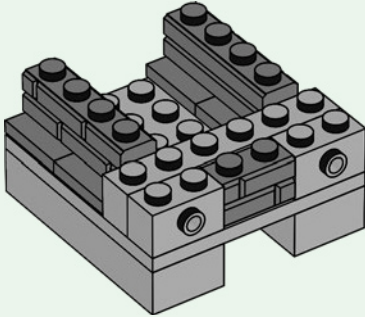

120

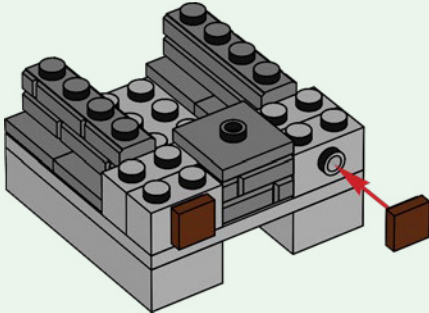

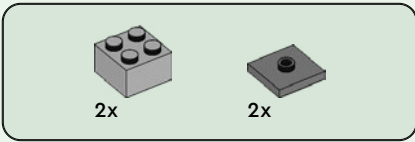

121

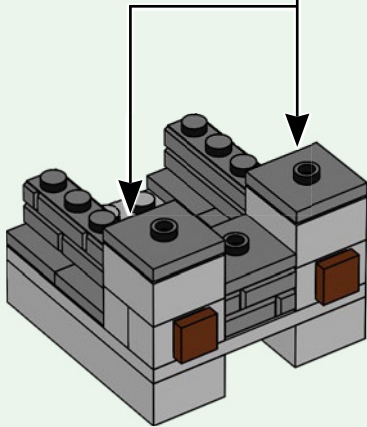
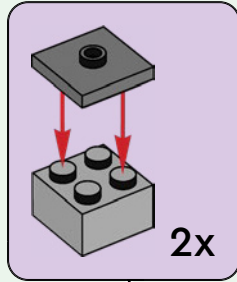

122

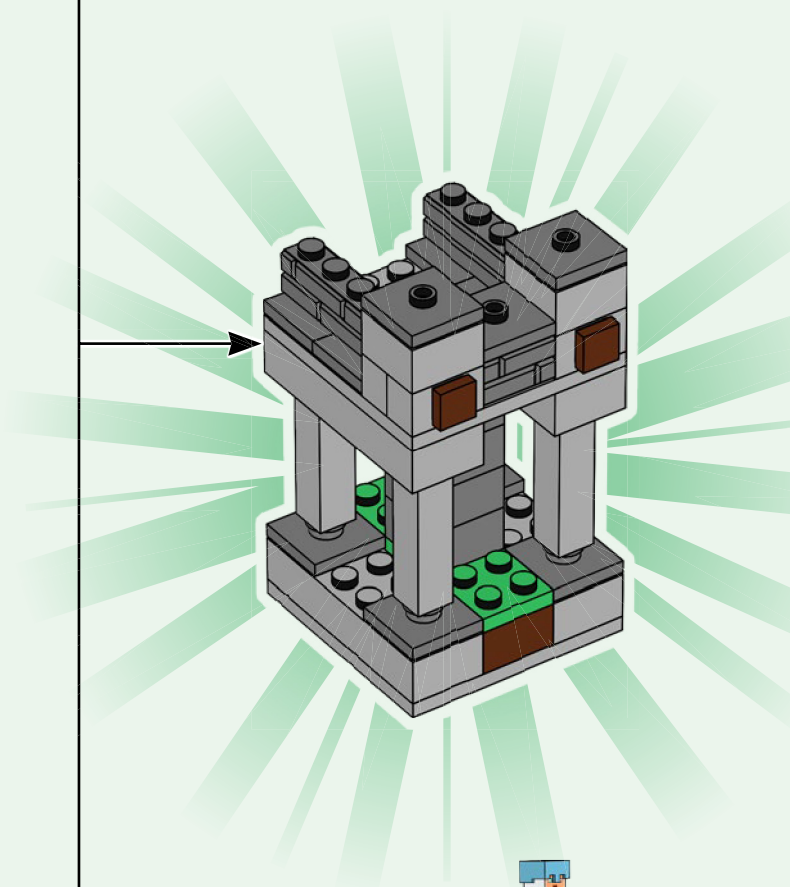

123

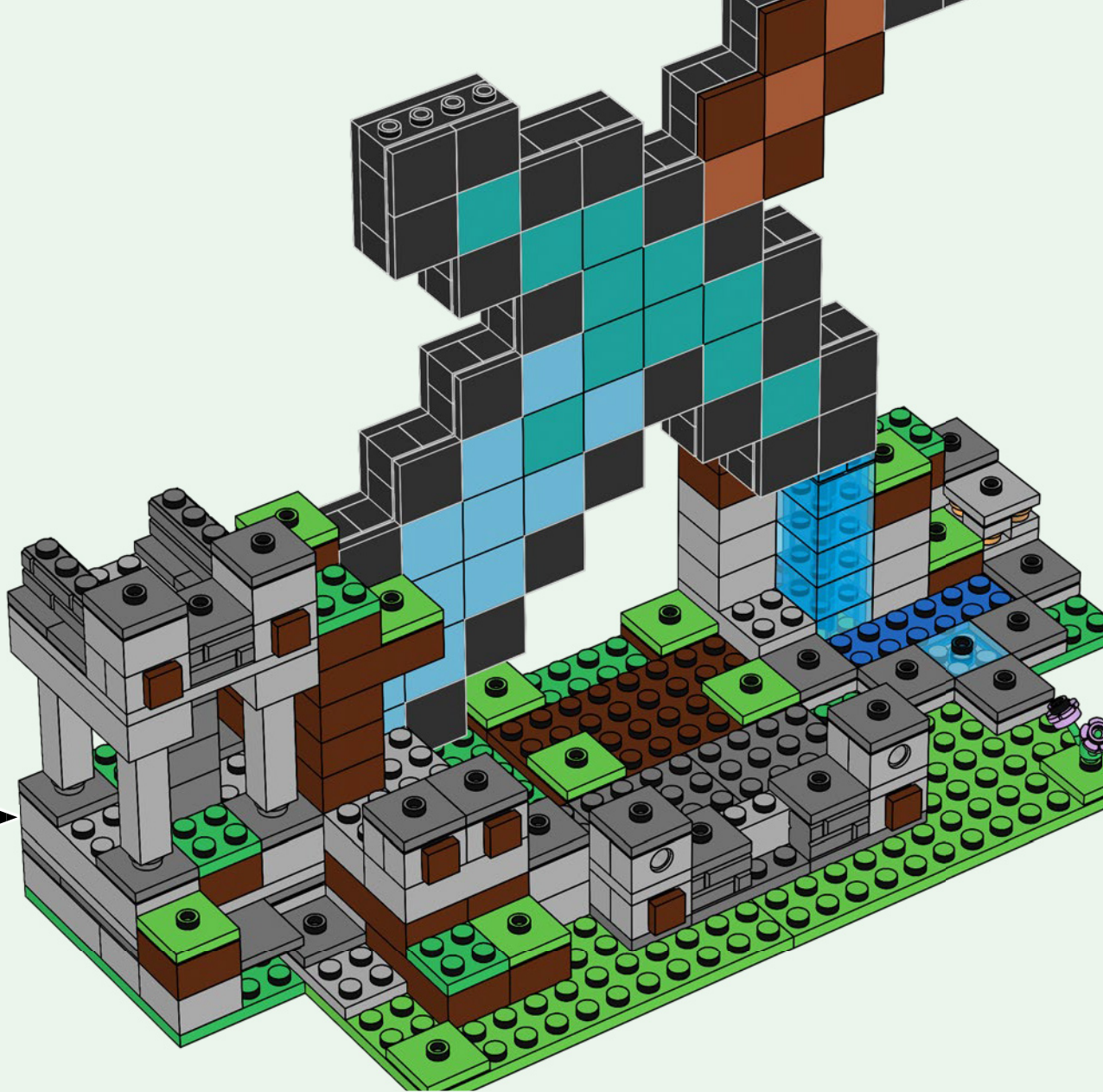

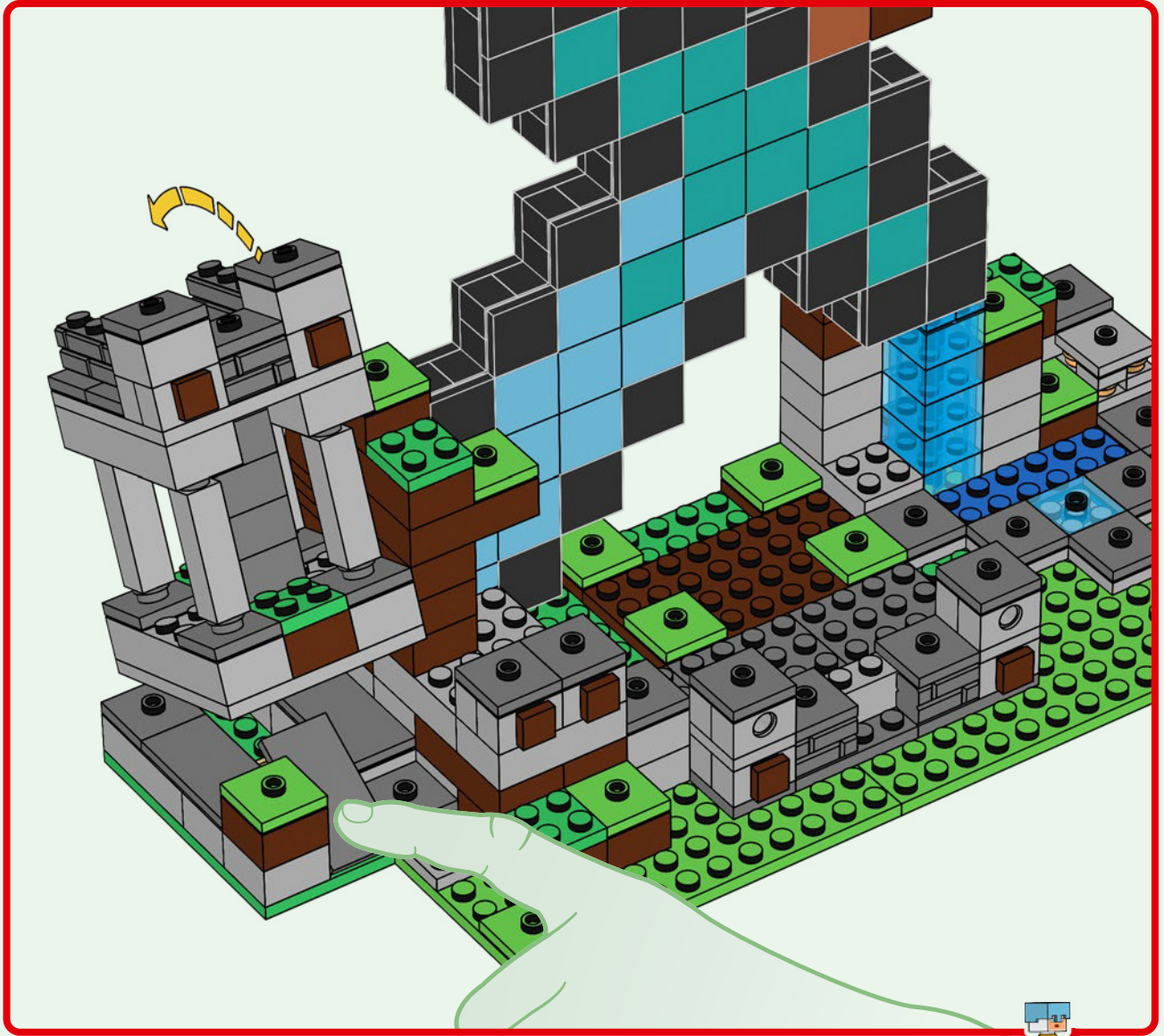

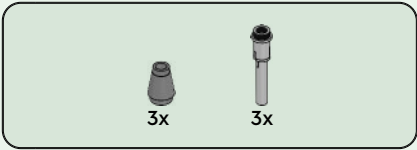

124

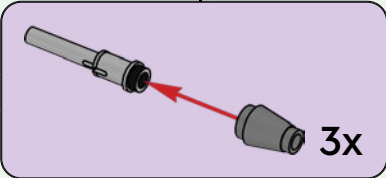
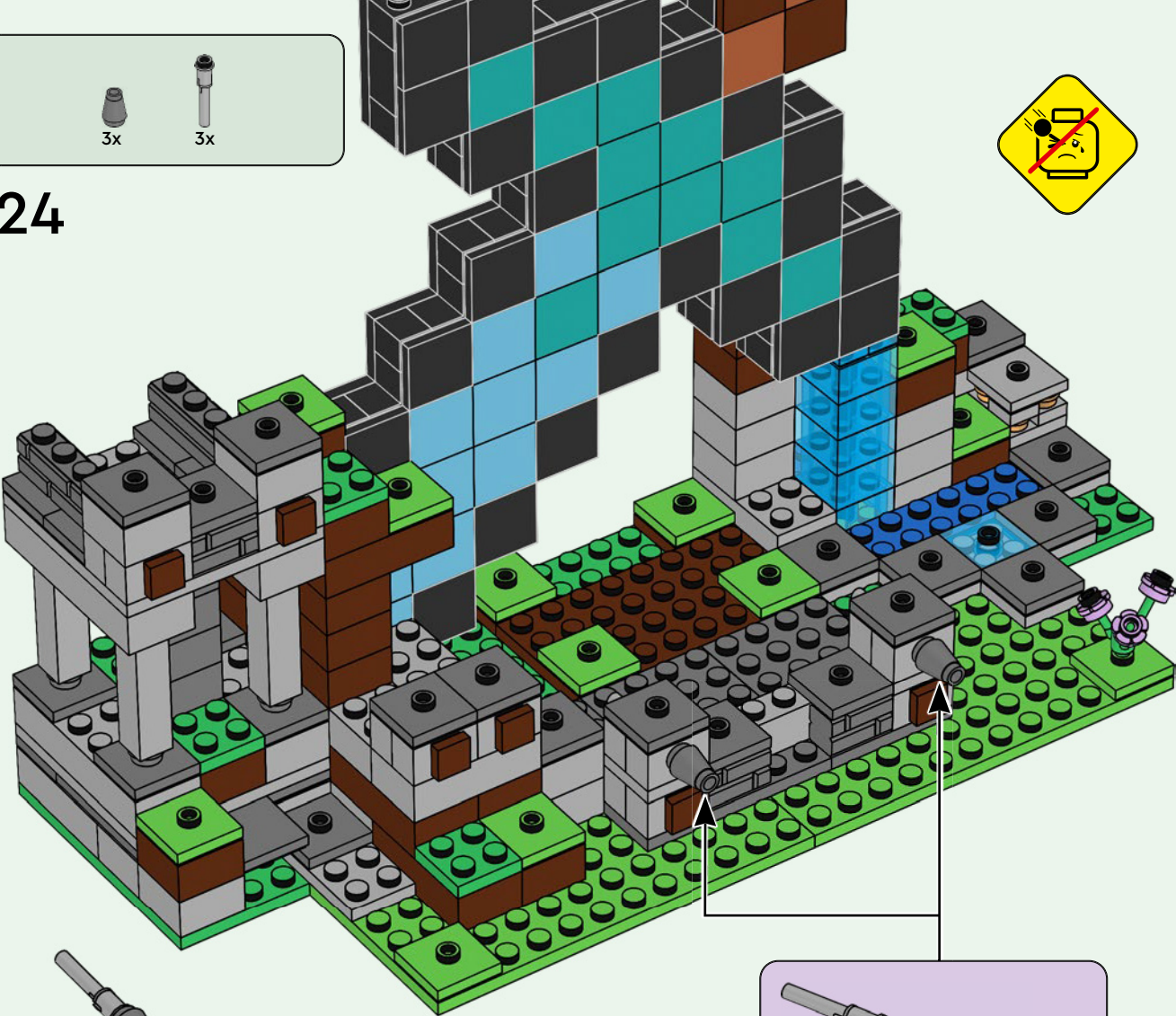

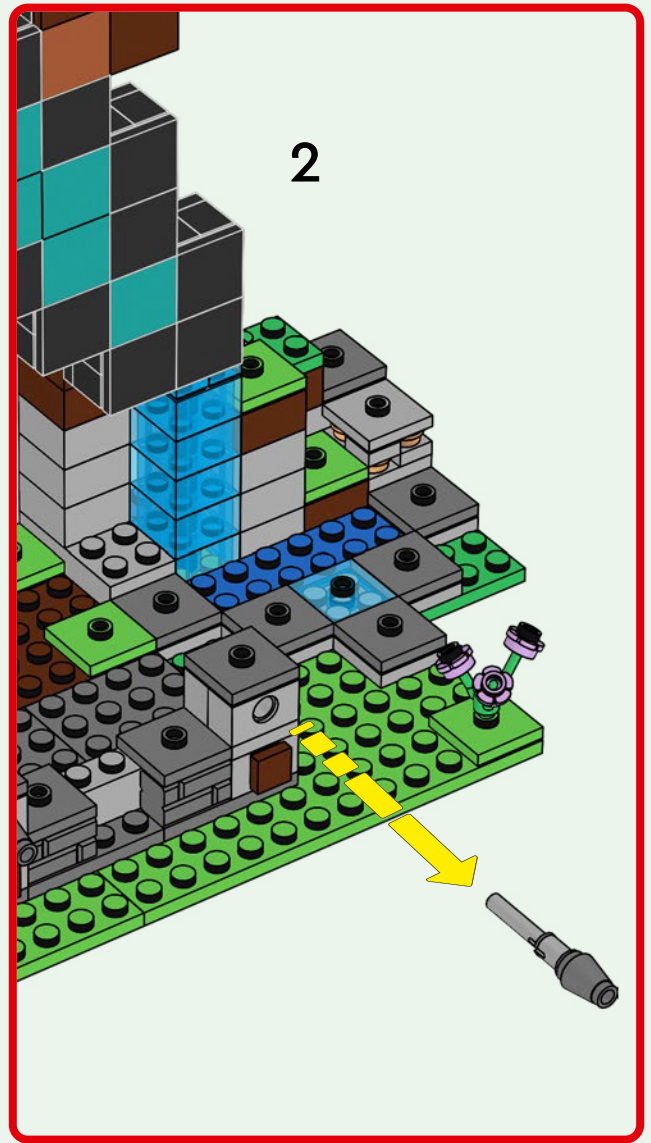
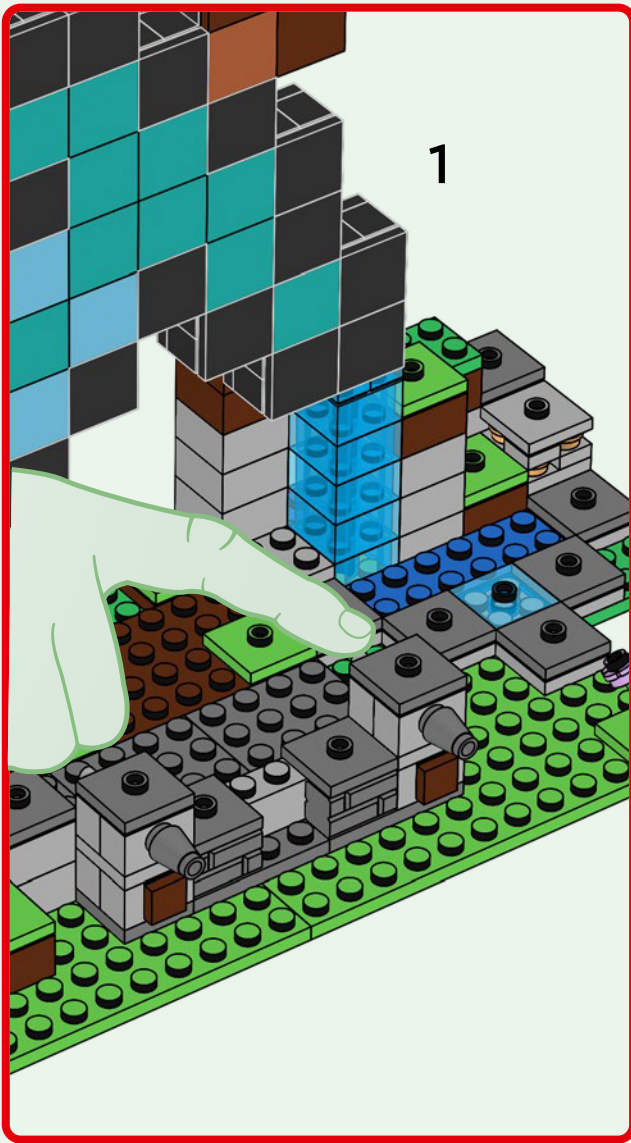

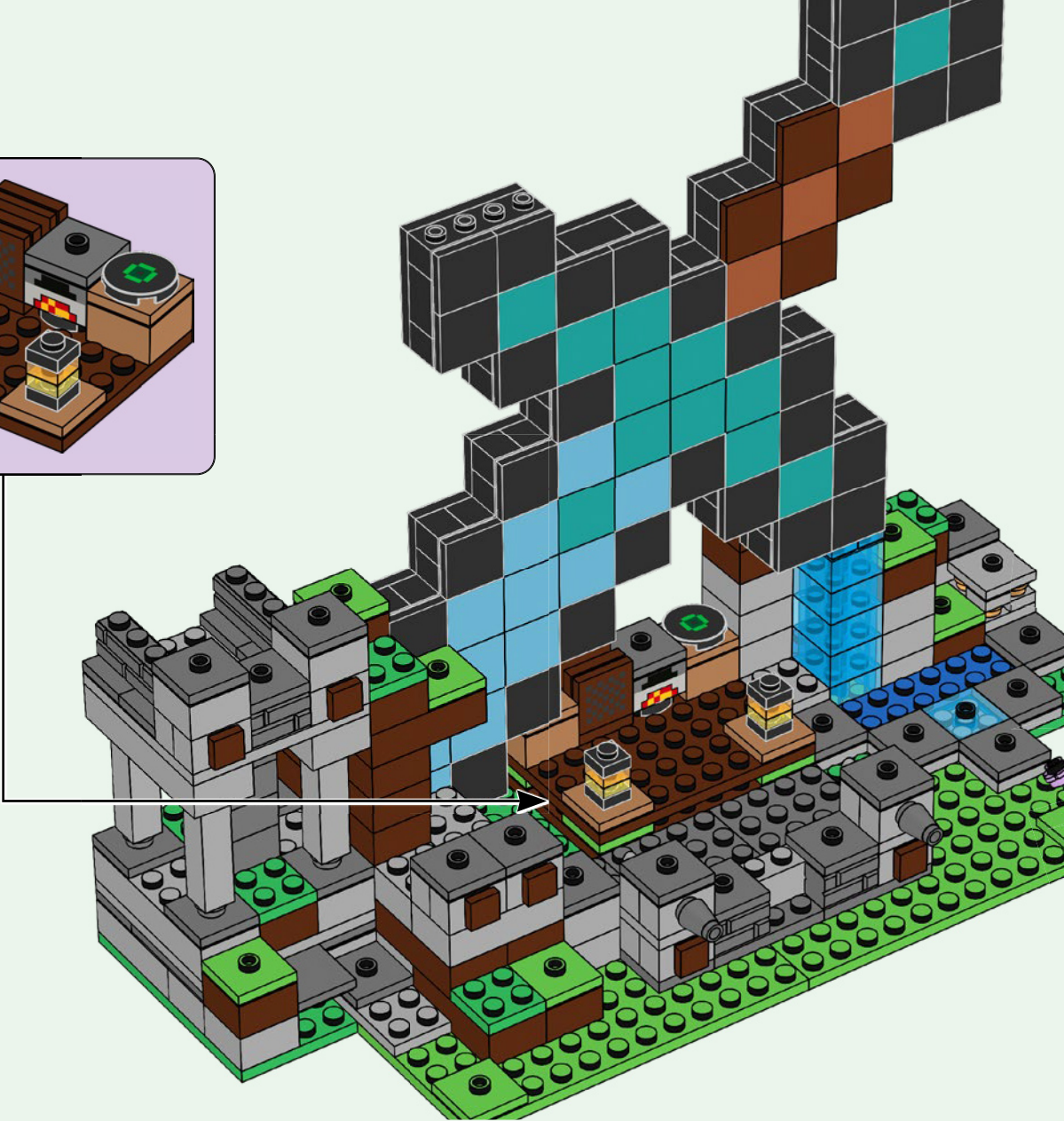





2x
6240495



2x
6252200



1x
6423961



1x
6162386



1x
6359891



1x
4205107



1x
6146221



1x
6054438



1x
302223



1x
379523



4x
302426



18x
300526



1x
6406405

106



1x
403226



1x
6423963



9x
300426



24x
235726



1x
302226



31x
306826



1x
281726



2x
4162443



5x
302026



2x
4243819

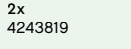

3x
379526

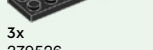

1x
300826

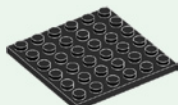

1x
395826



5x
383226



1x
6223655



1x
6425449



1x
6162485



1x
6269971



2x
306928



6x
302228



1x
6192875



1x
379528

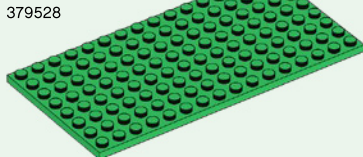

2x
4610602



12x
6389695

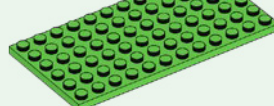

2x
4541414



3x
6186423



1x
6424322



2x
6251289



5x
6238043



1x
6382531



2x
6252045



12x
6273853



1x
4162916



1x
6432224



2x
6252040



2x
6252040



1x
6430973



6x
4211288



1x
4211150



1x
4211151



1x
6290983



1x
6089103



10x
4211210



4x
4271949



5x
4216695



1x
6430841



10x
4211201



2x
4211186



2x
4216615



1x
4211207



1x
4223729

4x
4523159

3x
6347715

4x
4211399

4x
6061702

1x
4211807

3x
6123809

6x
4211398

6x
6383177

4x
4211440

3x
4211388

1x
6126082

12x
4211397

2x
4211349

7x
4211387

1x
4211394

3x
4211395

14x
4211385

1x
4211393

7x
4211795

2x
4211474

1x
4211521

8x
4210633

3x
4529240

3x
6000311

1x
6216860

1x
6216862

30x
6126083

4x
4211060

2x
6055310

3x
4560184

1x
4211002

2x
4211115

2x
6291009

1x
6290525

1x
6096589

2x
6102999

12x
6060857

1x
6093623

1x
6104570

1x
6192828

3x
4653970

4x
4625629

6x
6022000

1x
6223733

1x
6431793

2x
6431796

1x
6423965

1x
6287854

4x
6102994

2x
6058085

3x
6214235

1x
6214216

1x
6431792



 [LEGO.com/service](https://www.LEGO.com/service)

YOU COULD **WIN**



Scan this QR code or go to **LEGO.COM/PRODUCTFEEDBACK** and give us your short feedback about this LEGO® set for a chance to win a cool LEGO prize.

Terms and Conditions apply*

DE: Du könntest GEWINNEN. Es gelten die Teilnahmebedingungen* **FR: Tu pourrais GAGNER.** Des conditions s'appliquent* **IT: Potresti VINCERE tu.** Termini e condizioni sono applicabili* **ES: Puedes GANAR.** Aplican términos y condiciones* **PT: Poderá GANHAR.** Aplicam-se termos e condições* **JA: プレゼント付き! 利用規約が適用されます*** **ZH: 轻松获奖. 条款和条件适用*** **KO: 상품의 주인이 되어보세요. 소정의 약관이 적용됩니다*** **RU: Вы можете ВЫИГРАТЬ.** Действуют положения и условия* **PL: Szansa na WYGRANĄ.** Obowiązują warunki korzystania* **CS: Máte šanci VYHRÁT.** Platí všeobecné smluvní podmínky* **SK: Máte šancu VYHRAŤ.** Platia všeobecné zmluvné podmienky* **HU: TE IS NYERHETSZ.** Felhasználási feltételek érvényesek* **RO: Ai putea CÂȘTIGA.** Se aplică termeni și condiții* **BG: Можете да СПЕЧЕЛИТЕ.** Има определени правила и условия* **LV: Tu vari LAIMĒT.** Ir spēkā noteikumi un nosacījumi.* **ET: Sul on võimalus VÕITA.** Kehtivad tingimused* **LT: Jūs galite LAIMĖTI.** Taikomos sąlygos*
*[LEGO.com/productfeedback-terms](https://www.lego.com/productfeedback-terms)

LEGO and the LEGO logo are trademarks of the/sont des marques de commerce du/son marcas registradas de LEGO Group. ©2023 The LEGO Group.



© 2023 Mojang AB. All Rights Reserved. Minecraft, the Minecraft logo, the Mojang Studios logo and the Creeper logo are trademarks of the Microsoft group of companies.

6448776