



SPEED
CHAMPIONS

76935



LEGO® Builder



Get excited about our new packaging!

We're switching from plastic to paper-based packaging. That's why you might find a mix of paper and plastic in our boxes!

Nos nouveaux emballages vous emballeront !

Nous passons des emballages en plastique aux emballages à base de papier. C'est pourquoi vous pourriez trouver un mélange de papier et de plastique dans nos boîtes !

¡Te presentamos nuestros nuevos empaques!

Estamos sustituyendo las bolsas de plástico por bolsas con base de papel. ¡Por eso, puedes encontrar una mezcla de papel y de plástico en nuestras cajas!

[LEGO.com/sustainable-packaging](https://www.lego.com/sustainable-packaging)

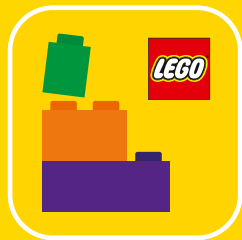

Q LEGO® Builder

BUILDER



Apple and the Apple logo are trademarks of Apple Inc., registered in the U.S. and other countries and regions. App Store is a service mark of Apple Inc. Google Play and the Google Play logo are trademarks of Google LLC. Tencent and the Tencent logo are trademarks of Tencent Inc.

Q [LEGO.com/devicecheck](https://lego.com/devicecheck)

EN Ask parents' permission before going online | **DE** Eltern um Erlaubnis bitten, bevor du online gehst | **FR** Demande l'autorisation d'un parent avant d'aller en ligne | **IT** Chiedi il permesso ai tuoi genitori prima di andare online | **ES** Pídeles permiso a tus papás antes de conectarte a Internet | **PT** Pede autorização aos pais antes de acederes online | **ZH** 上网前应先征得父母的同意 | **PL** Poproś rodziców o zgodę, zanim wejdziesz do Internetu | **CS** Než půjdeš na internet, požádej rodiče o svolení | **SK** Skôr než pôjdeš na internet, vypýtaj si povolenie od rodičov | **HU** Kérj szülői engedélyt, mielőtt online csatlakoznál! | **RO** Cere permisiunea părinților înainte de a te conecta online | **BG** Поискайте разрешение от родител, преди да влезете онлайн | **LV** Pirms došanās tiešsaistē palūdz atļauju vecākiem | **ET** Enne Interneti kasutamist küsi vanematelt luba | **LT** Prieš prisijungdami prie interneto, atsiklauskite tėvų

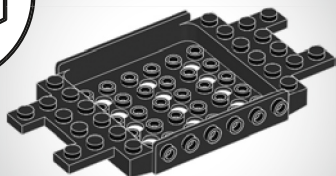
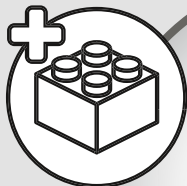

1

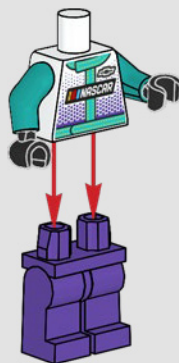

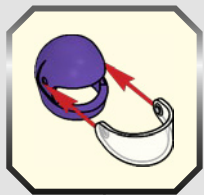

2

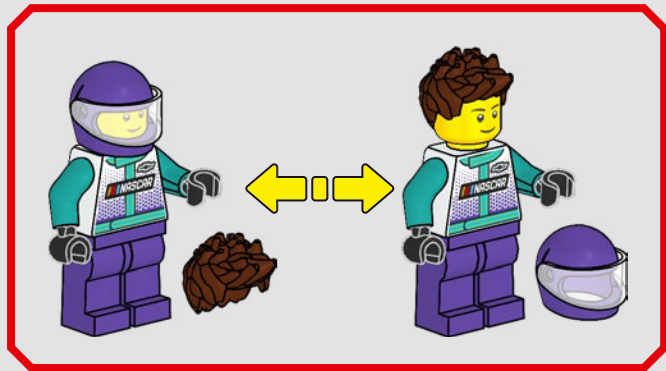
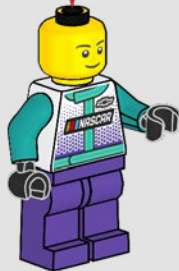

3



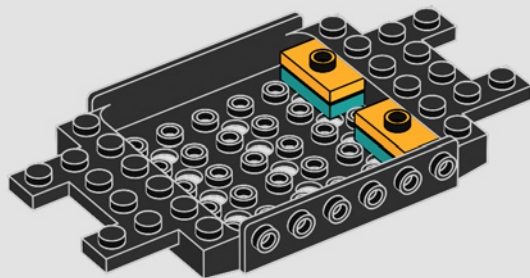
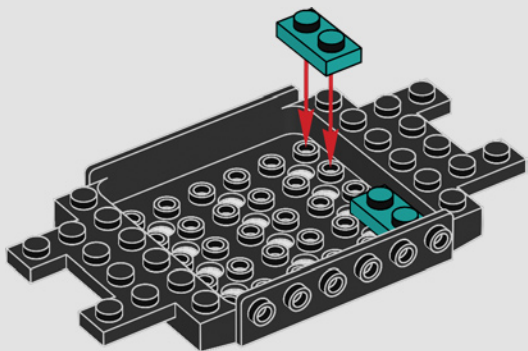
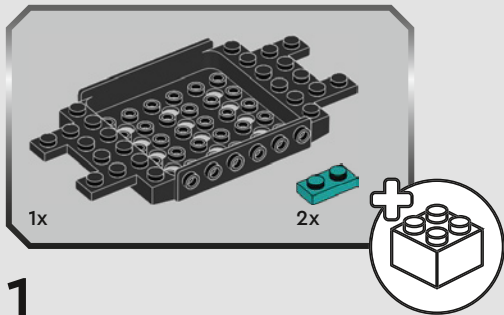

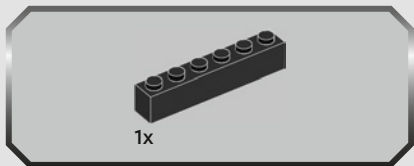

3

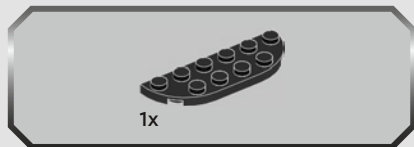
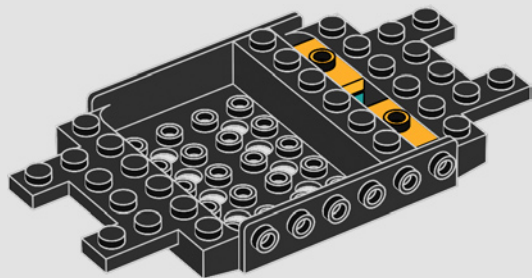

4

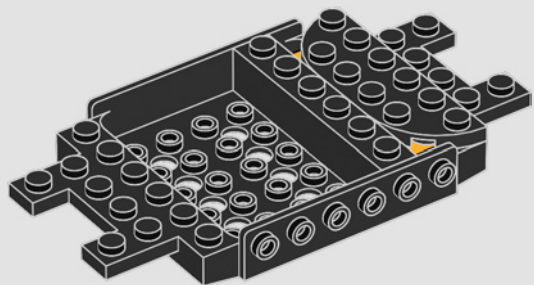



5

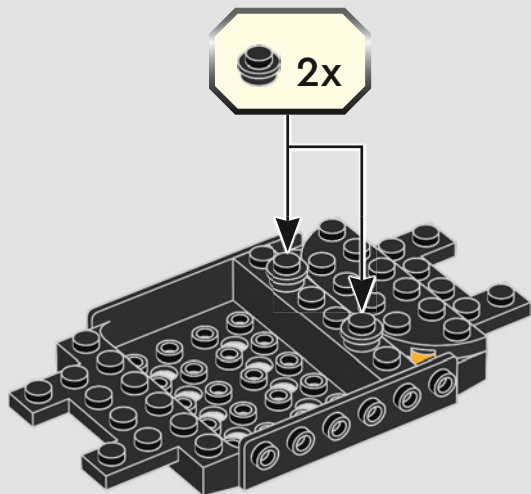

6

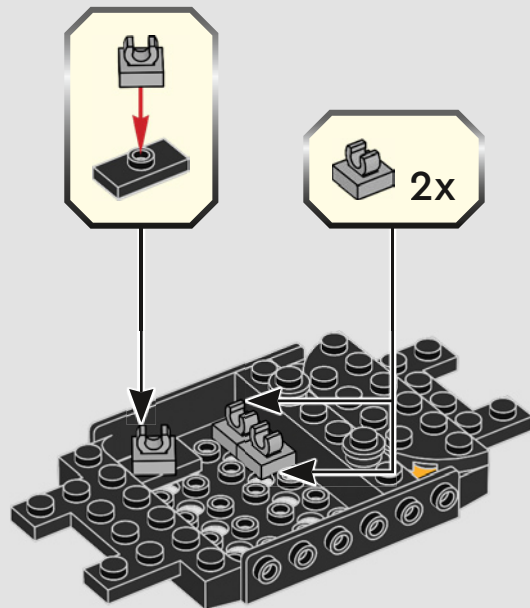

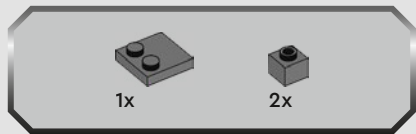

7

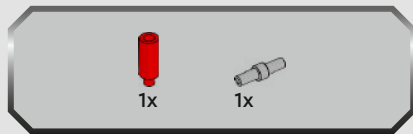
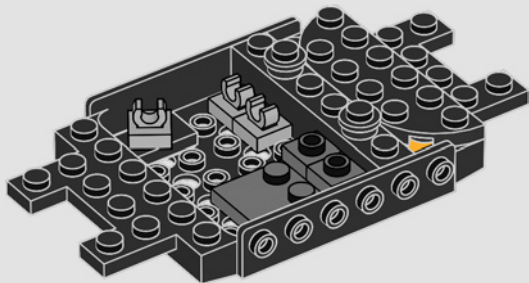

8

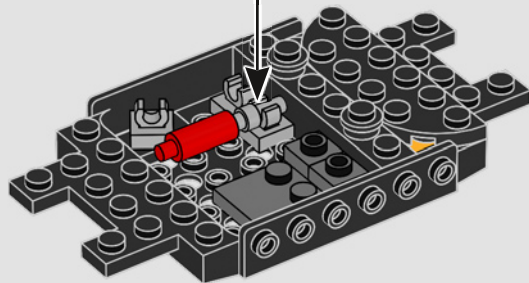
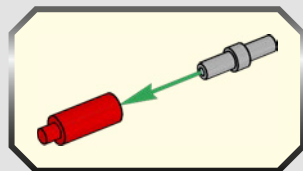



9

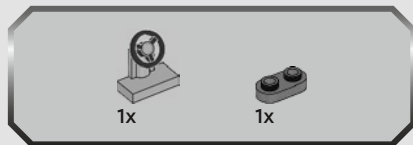
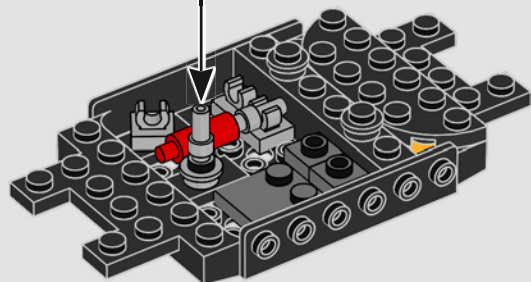
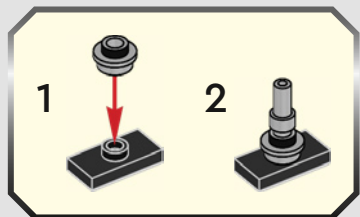

10

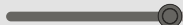
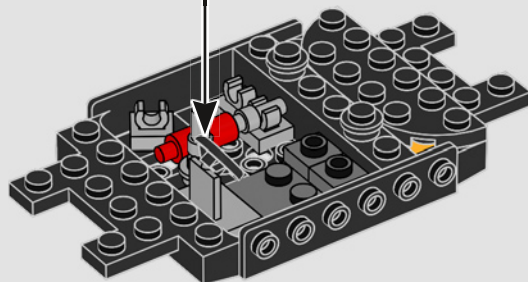
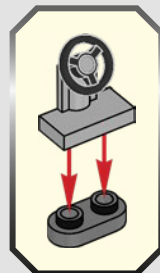

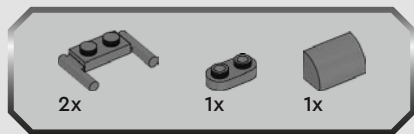

11

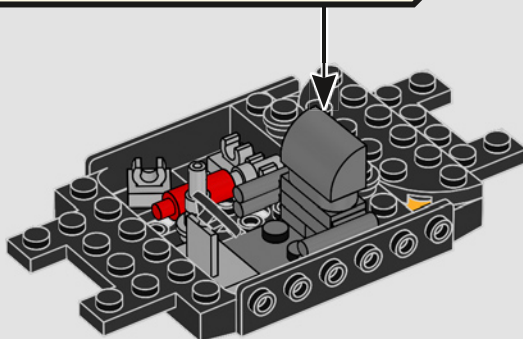
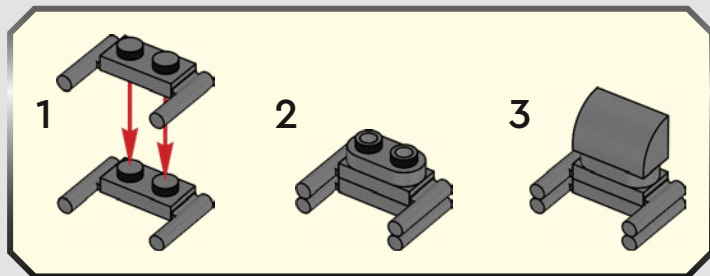

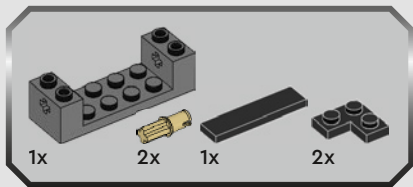

12

1

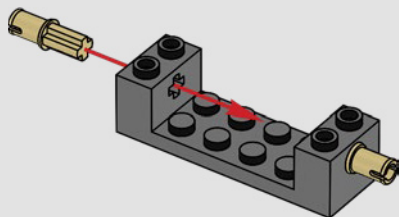

2

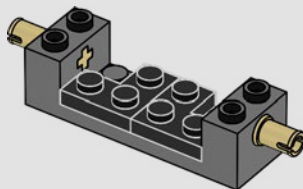

3

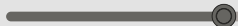
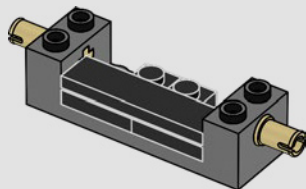

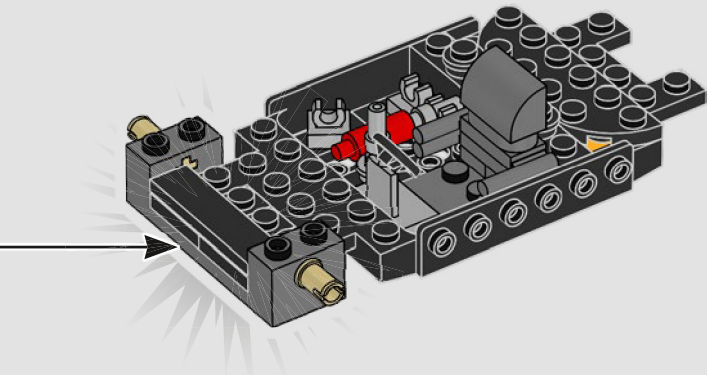

13

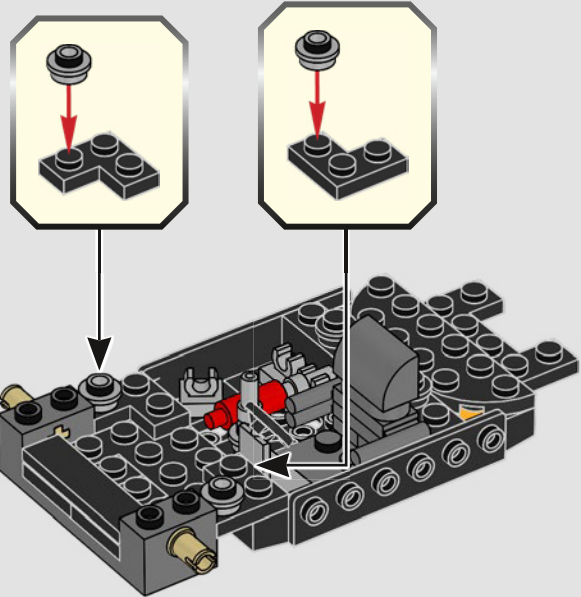



14

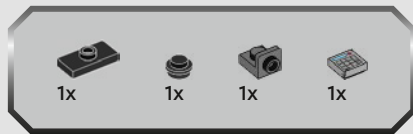
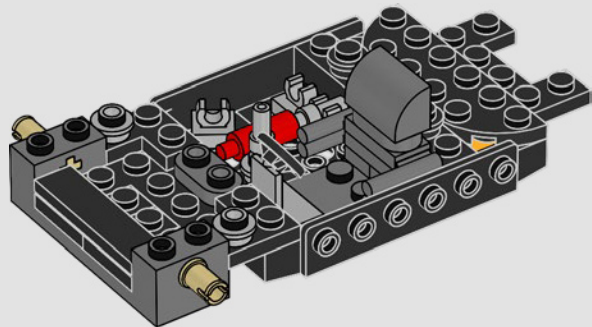

15

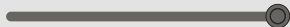
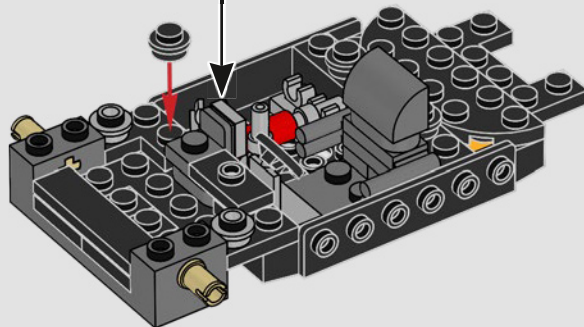
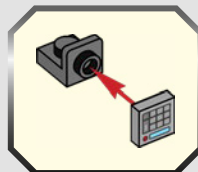

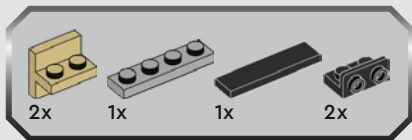

16

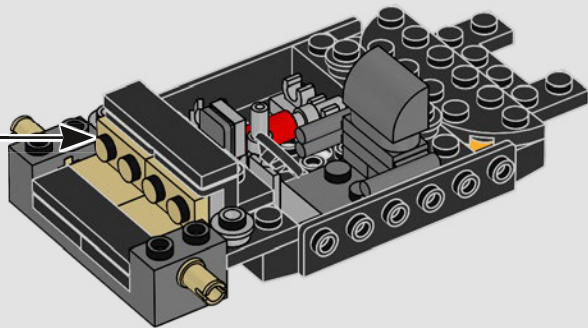
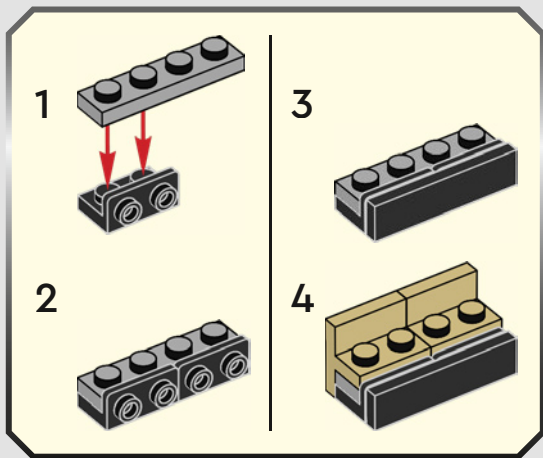



17

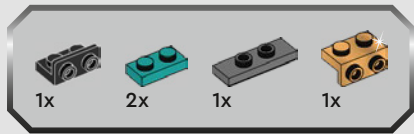
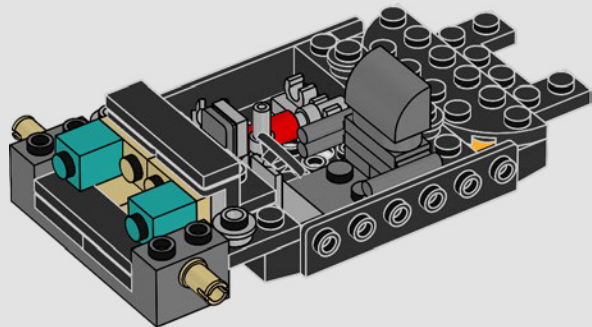

18

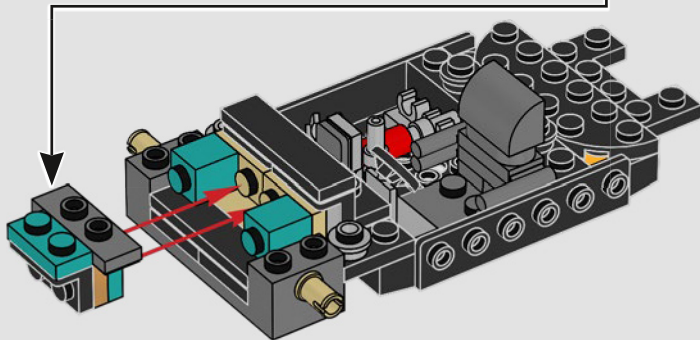



19

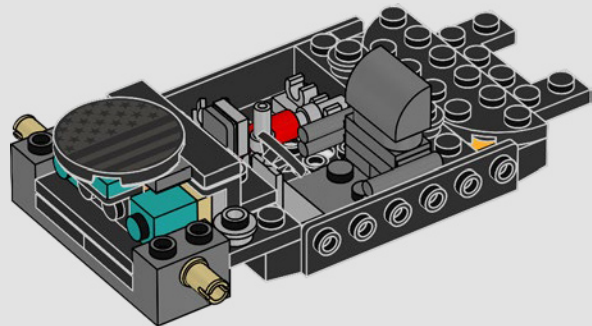

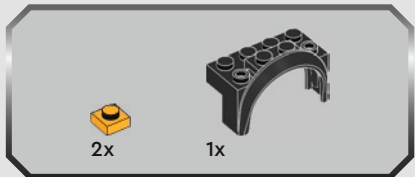

20

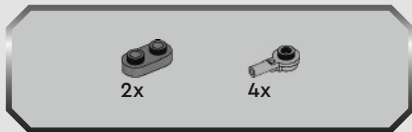
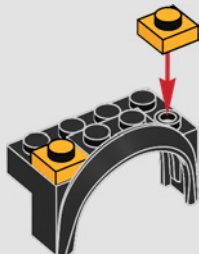

21

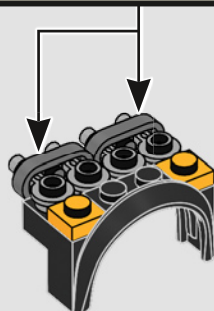
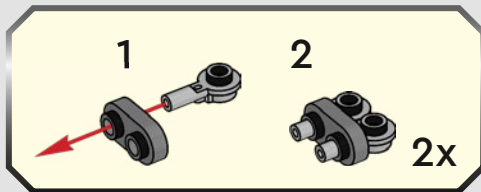



22

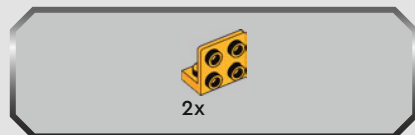
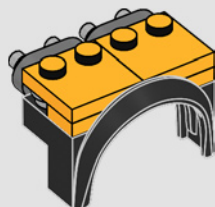

23

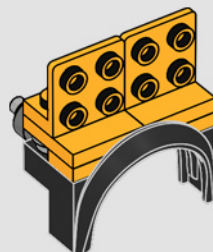

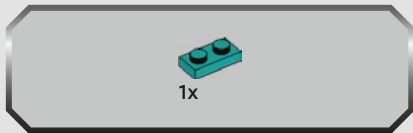

24

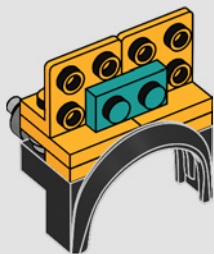

25

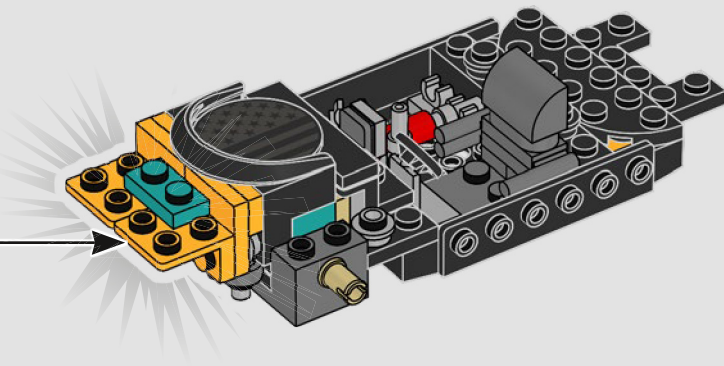



26

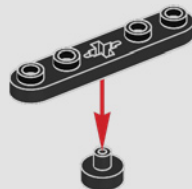



2x

27

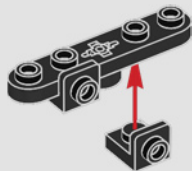

2x

28

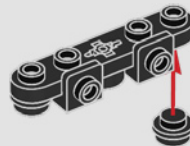

2x

1x

29

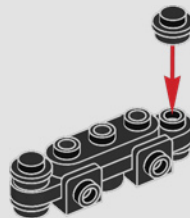



30



31

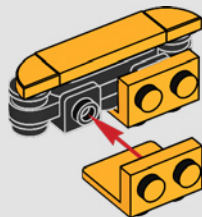



32

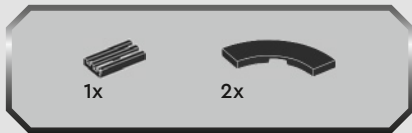
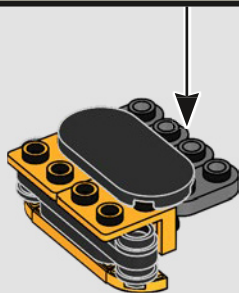
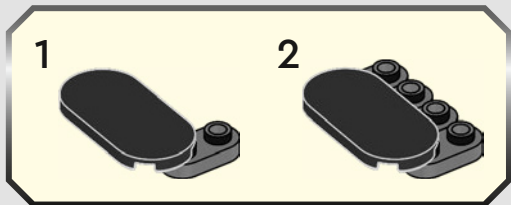

33

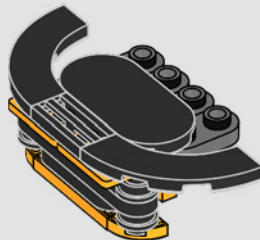

34

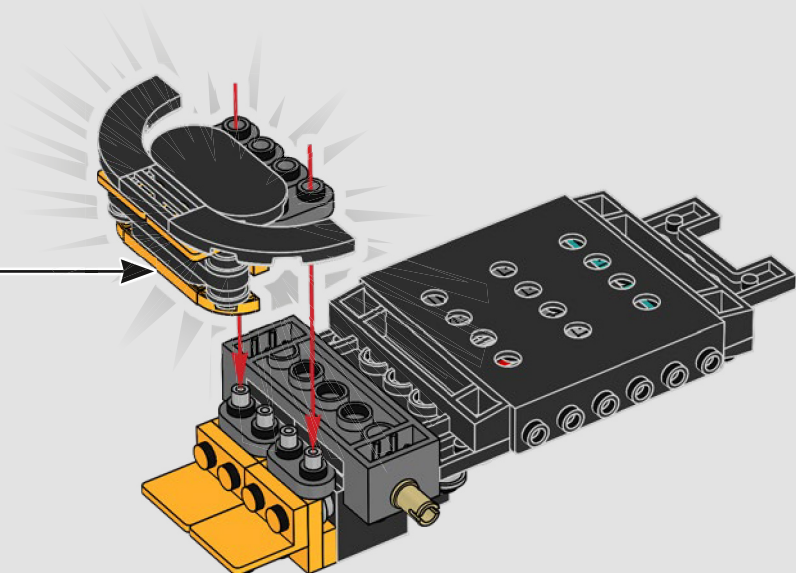



35

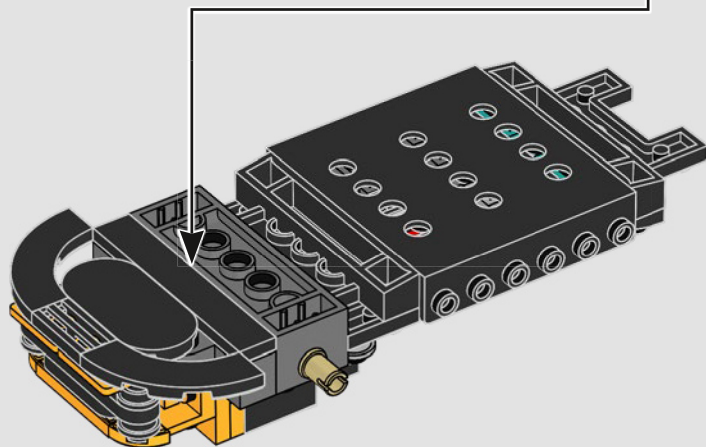
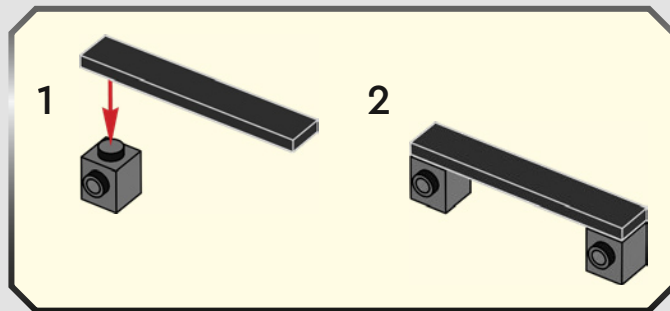

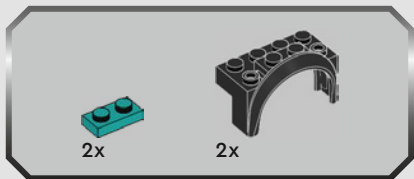

36

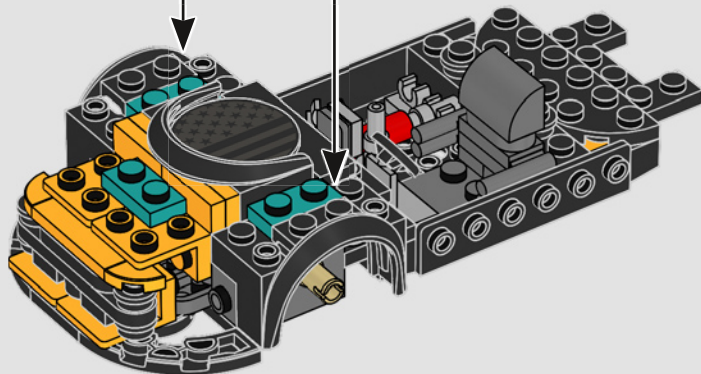
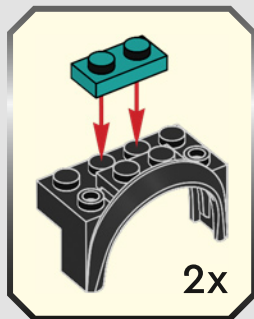

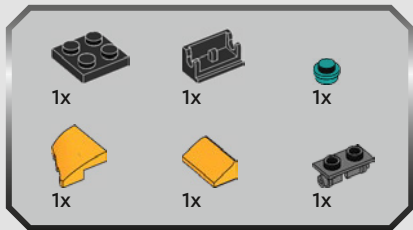

37

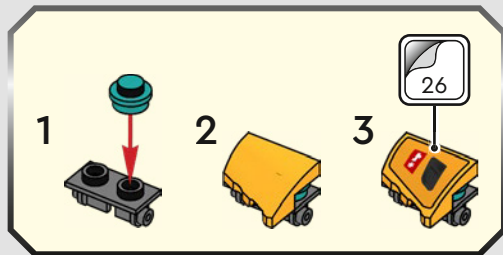
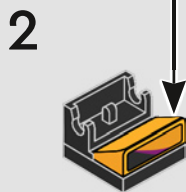
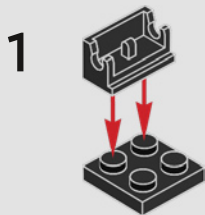
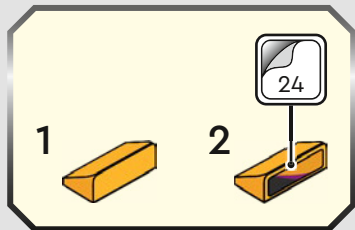

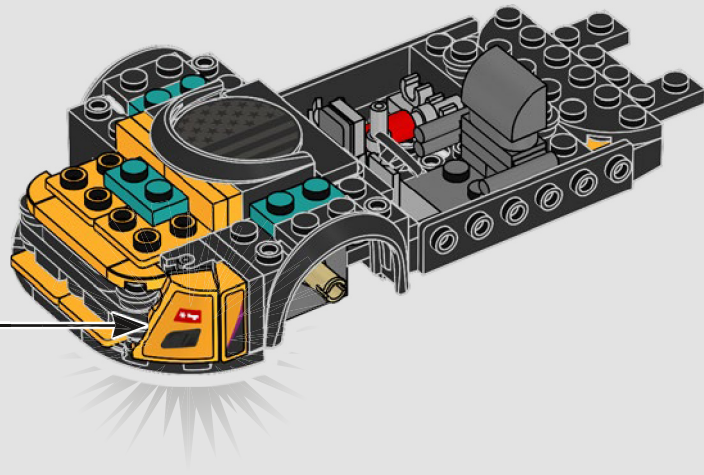

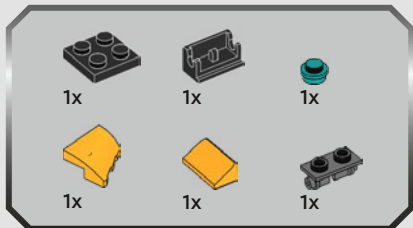

38

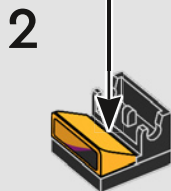
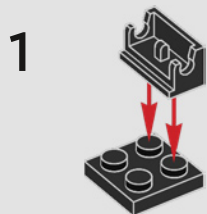
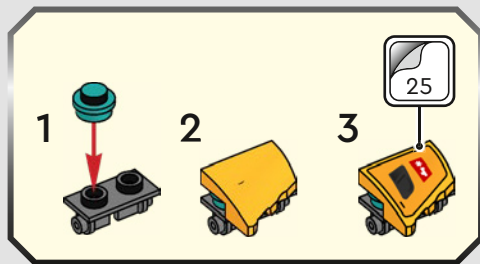
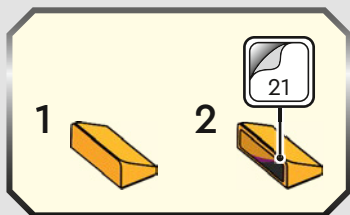

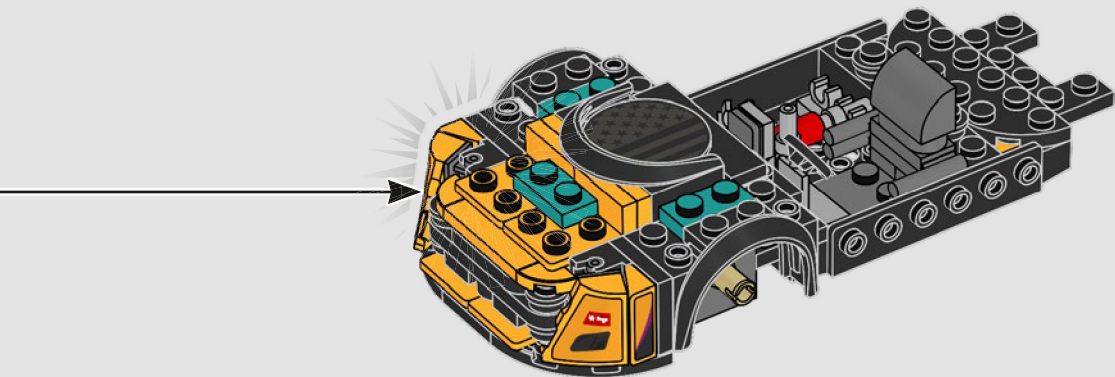



2x



2x

39

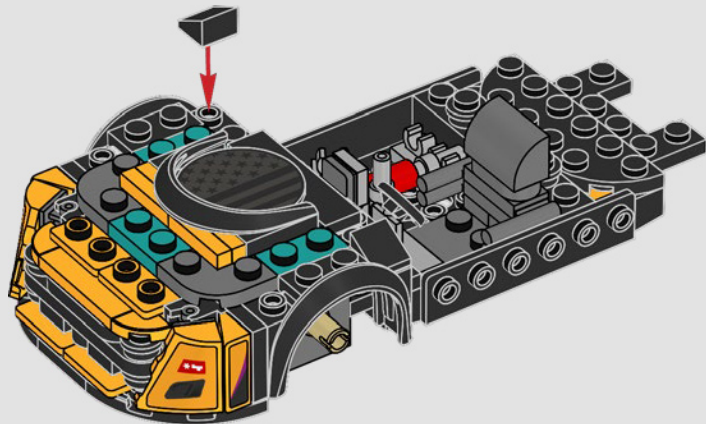

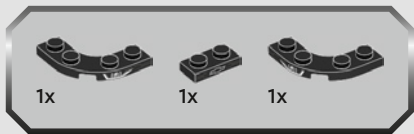

40

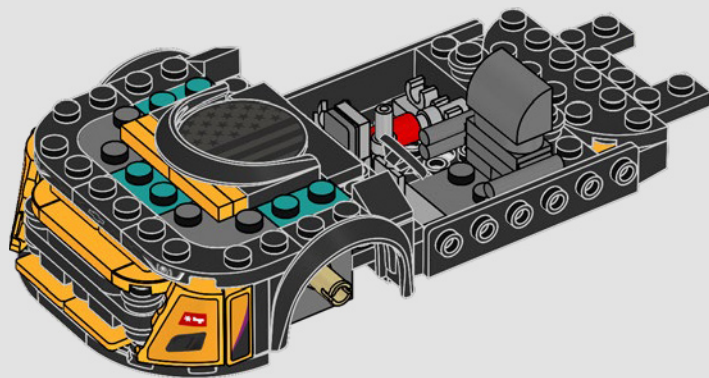



41

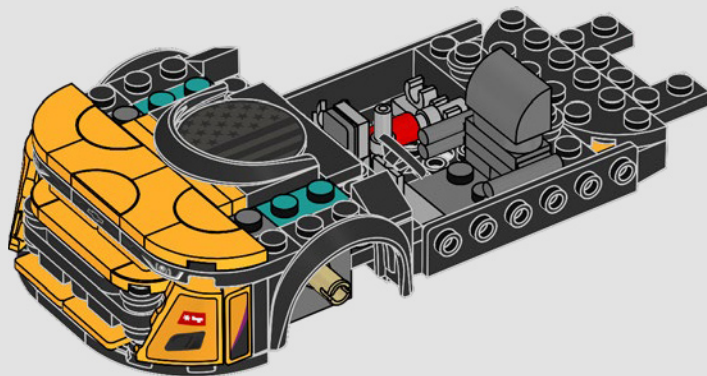



42

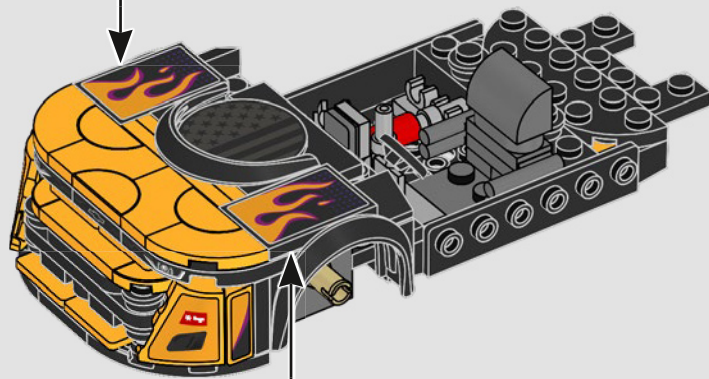
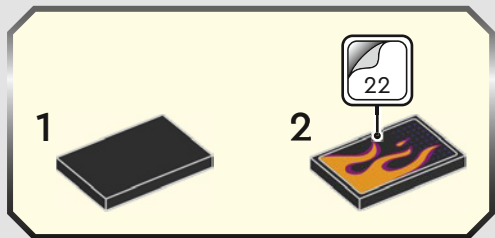

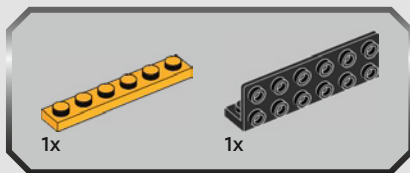

43

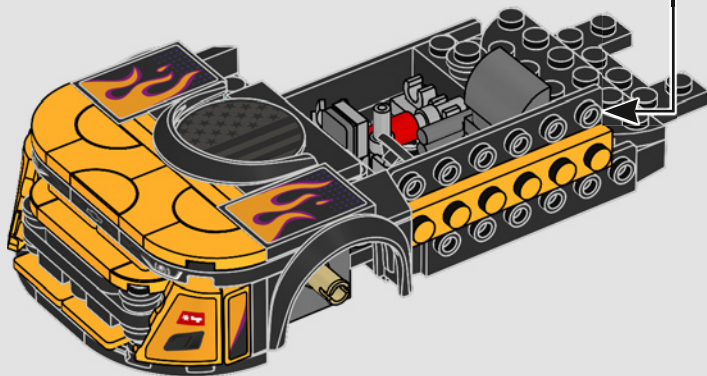
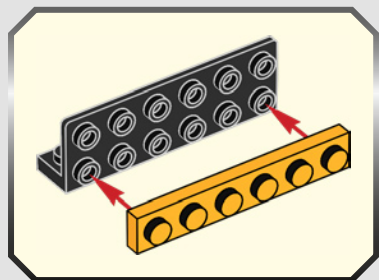



44

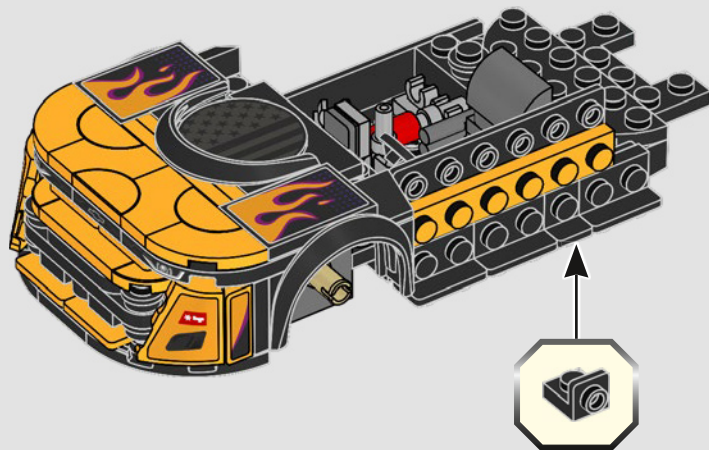

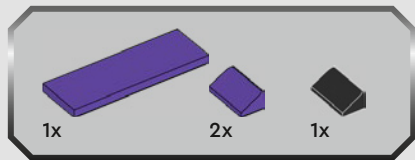

45

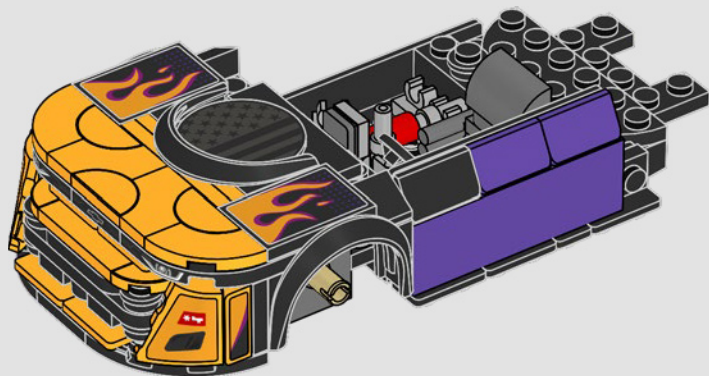

46

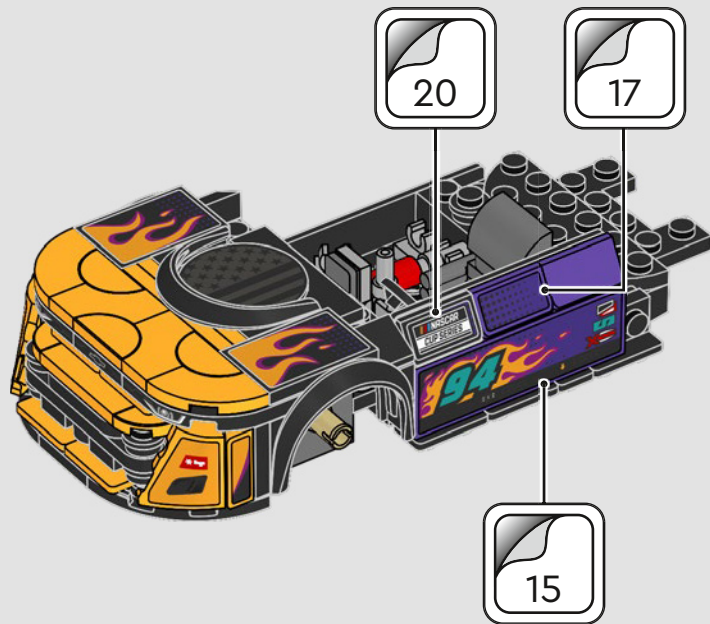

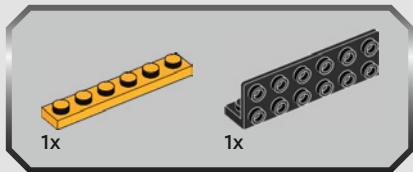

47

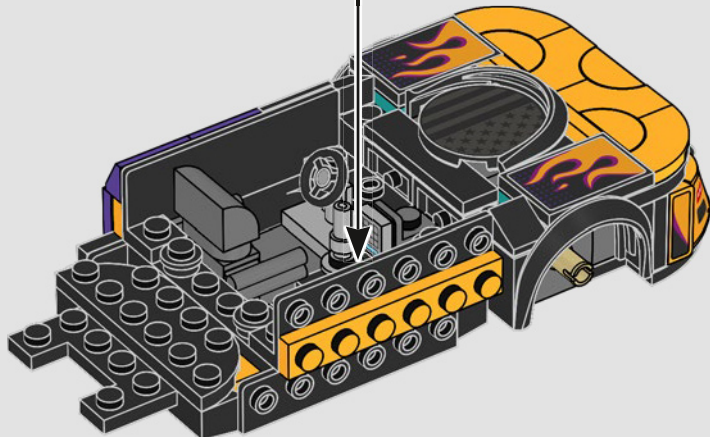
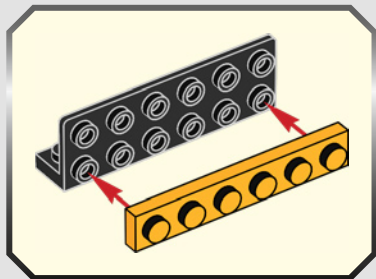



48

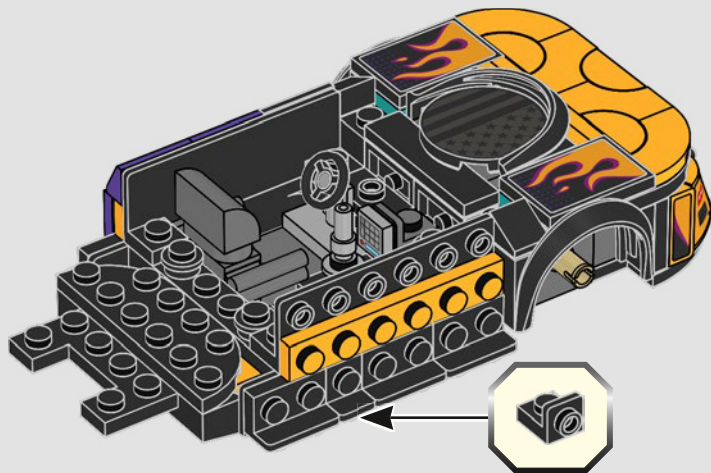

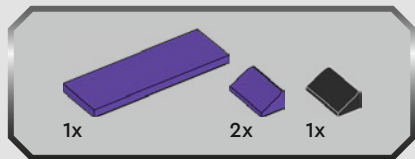

49

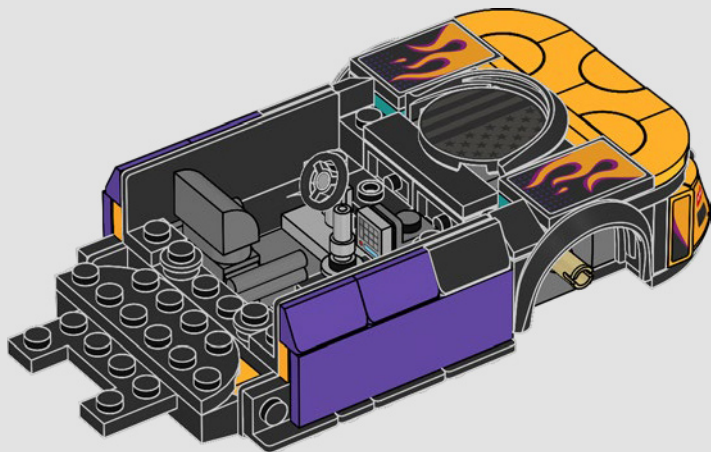

50

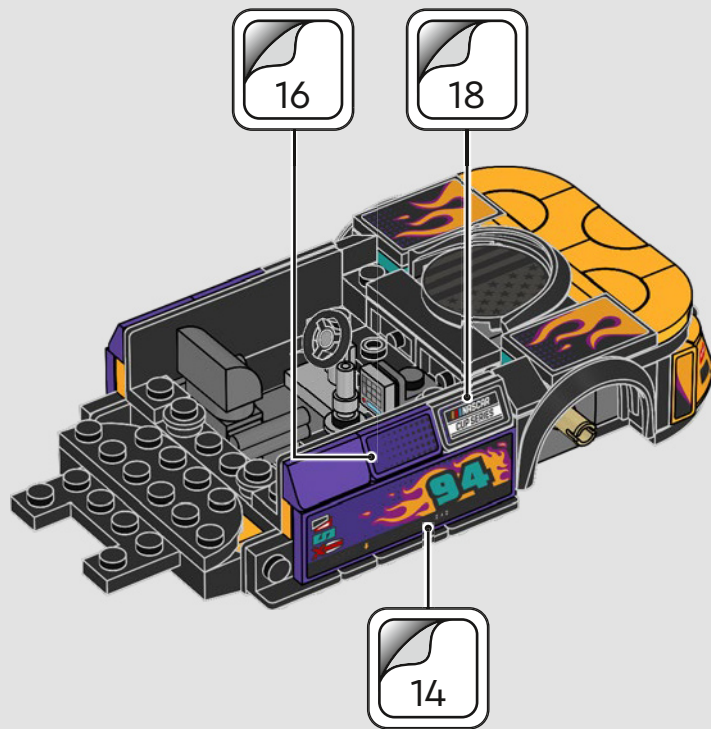

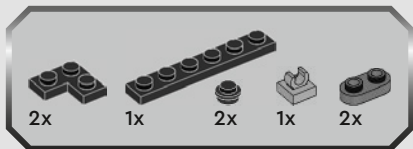

51

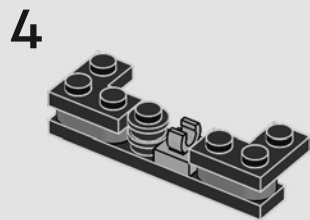
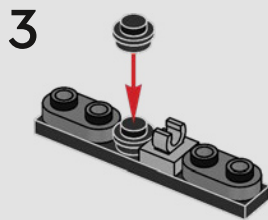
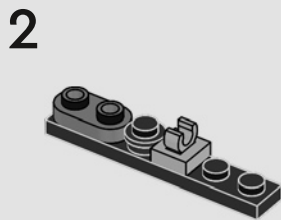
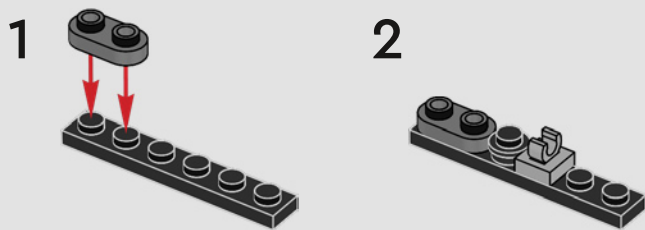

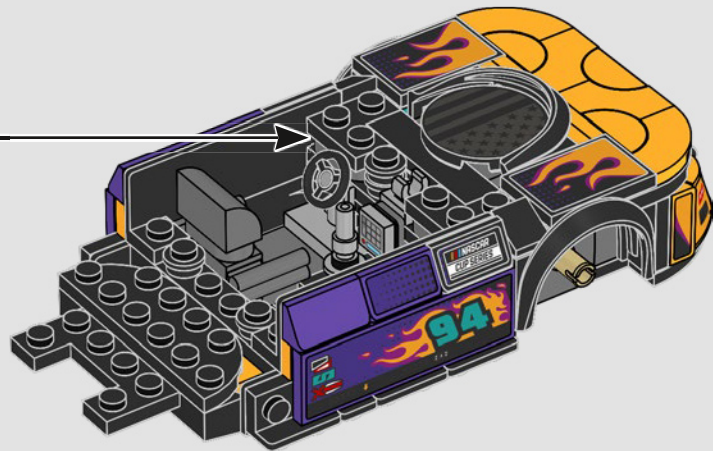



1x



2x

52

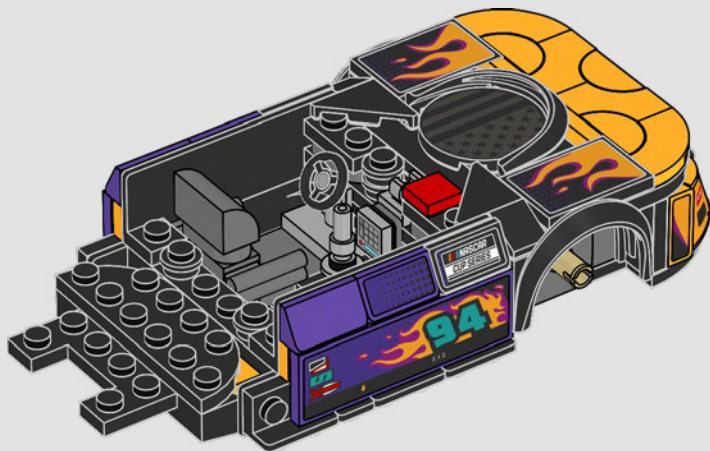



53

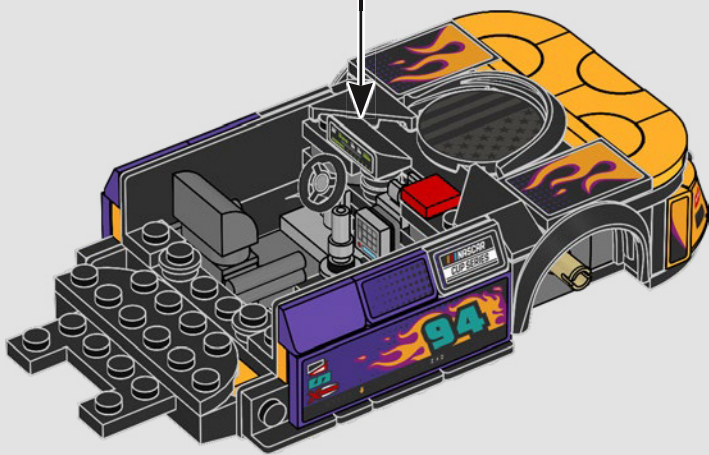
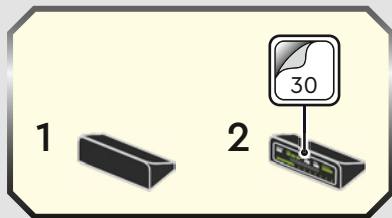

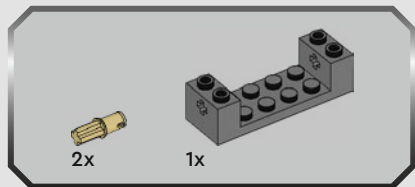

54

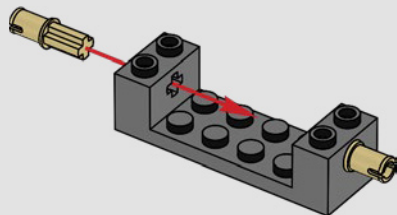

55

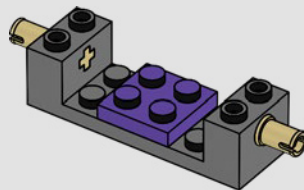

56

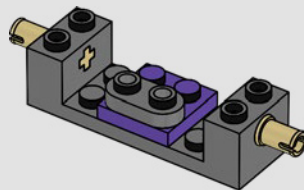



57

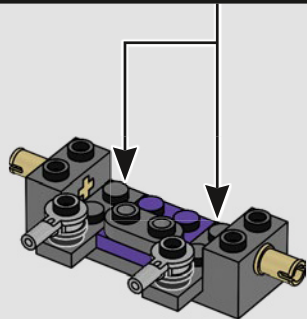
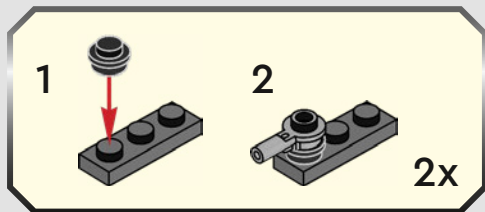

58

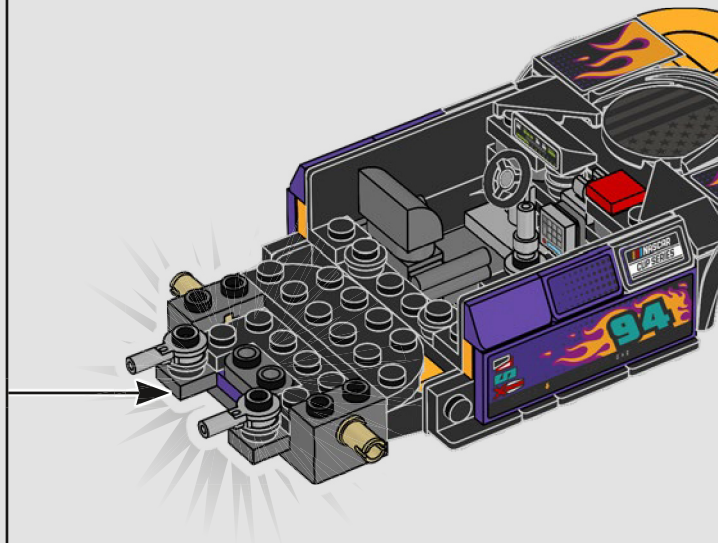



1x

59

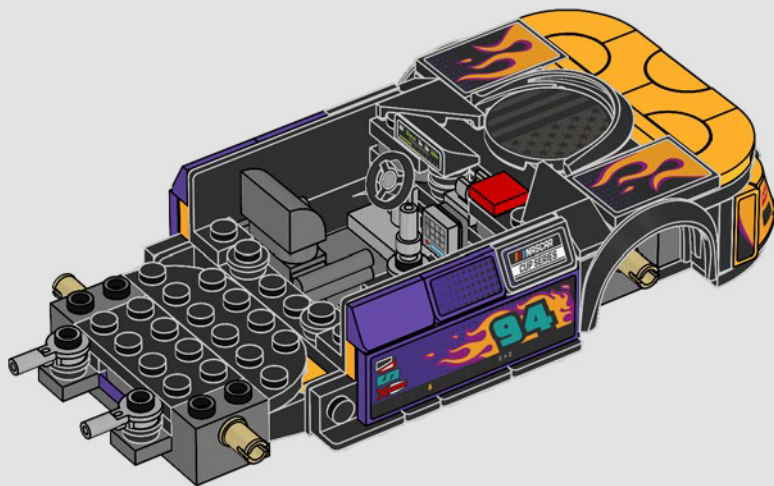



60

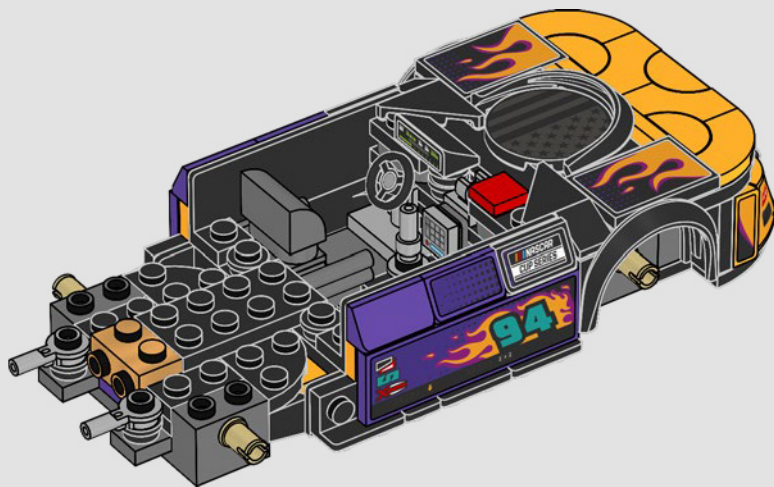

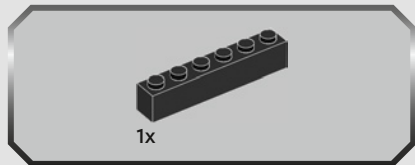

61

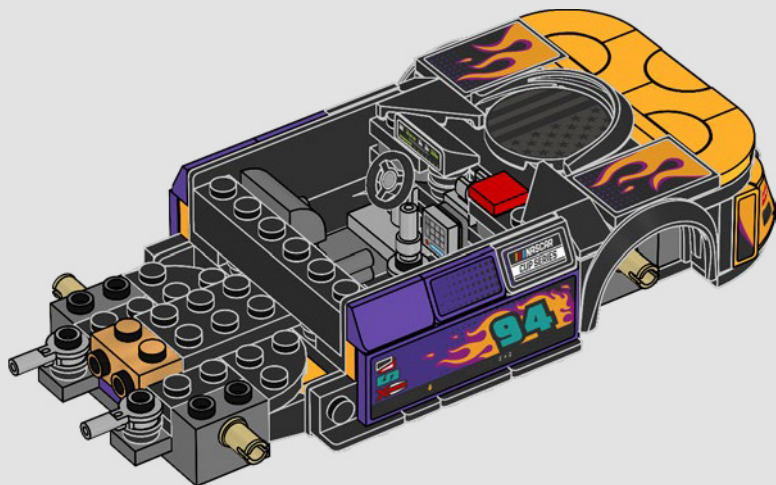

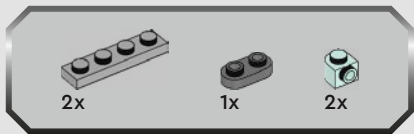

62

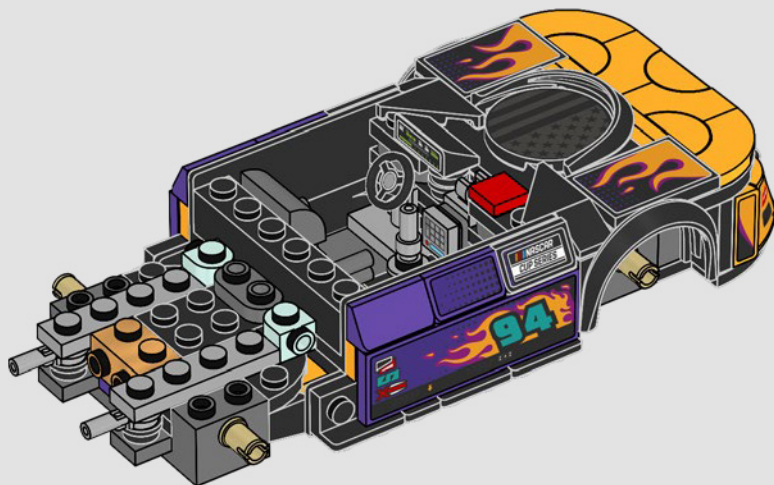



2x



1x

63

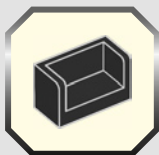

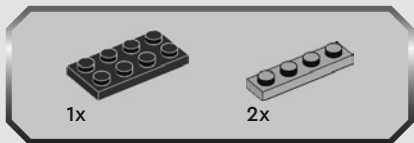

64

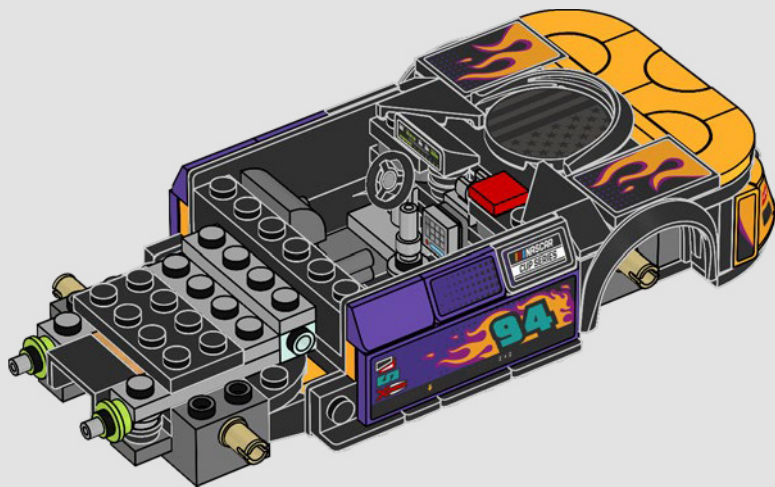

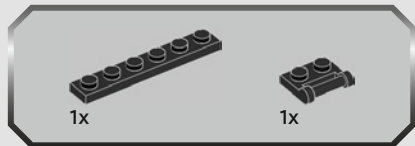

65

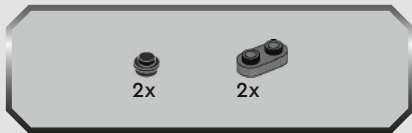
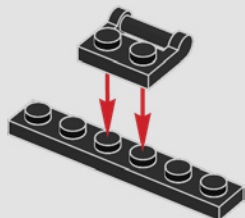

66

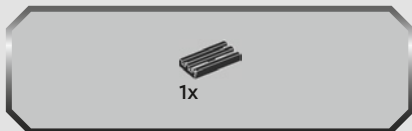
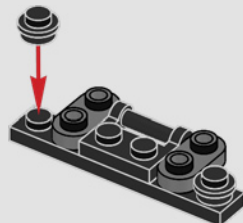

67

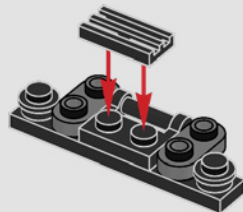

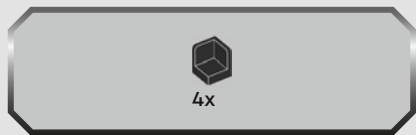

68

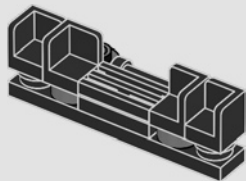

69

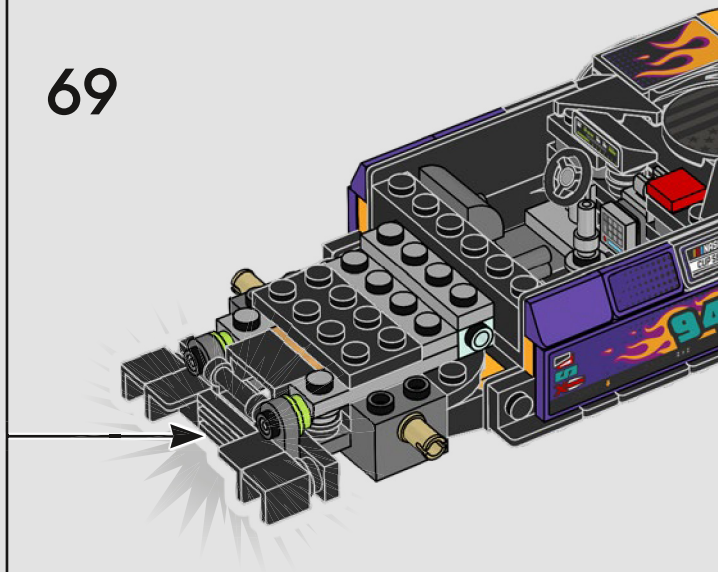



70

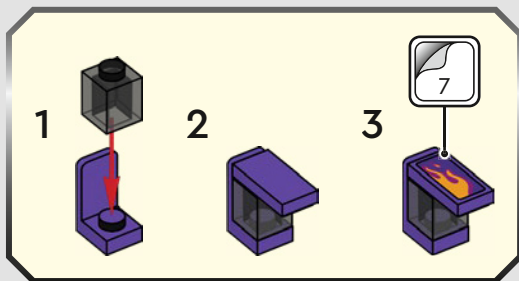



71

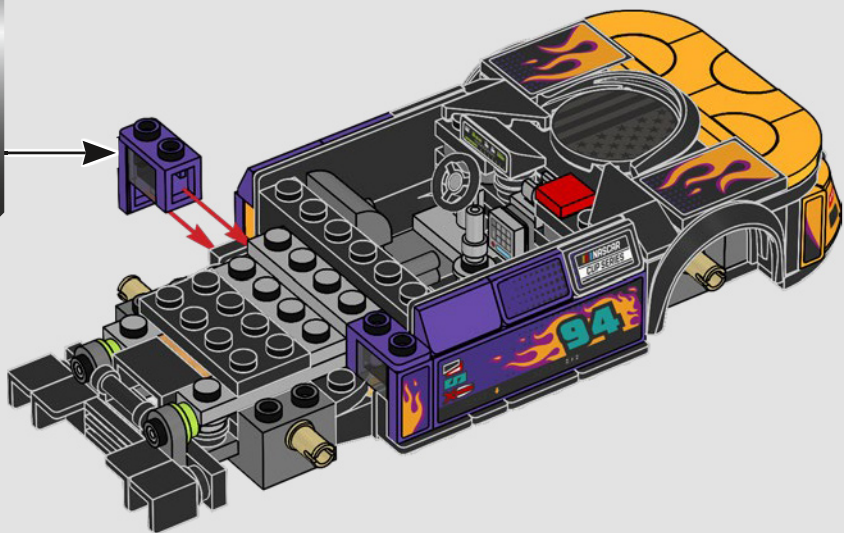
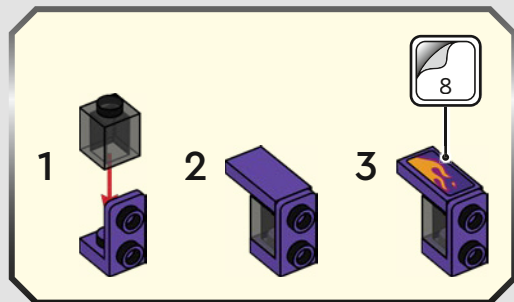

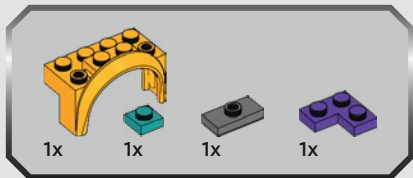

72

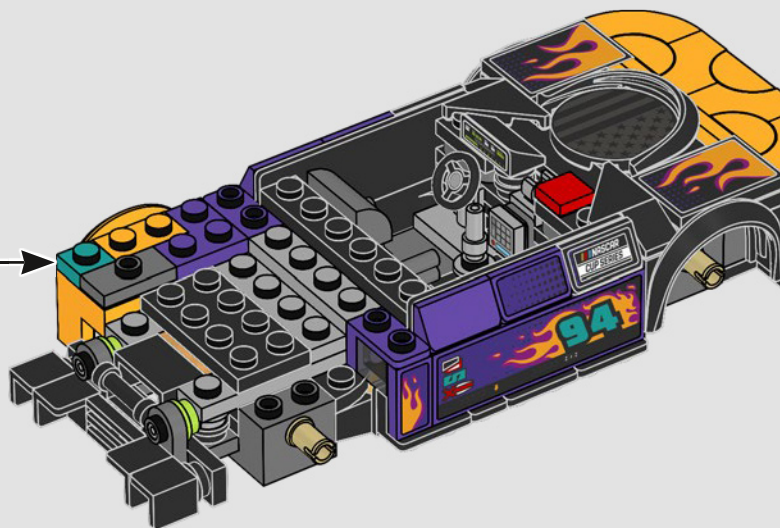
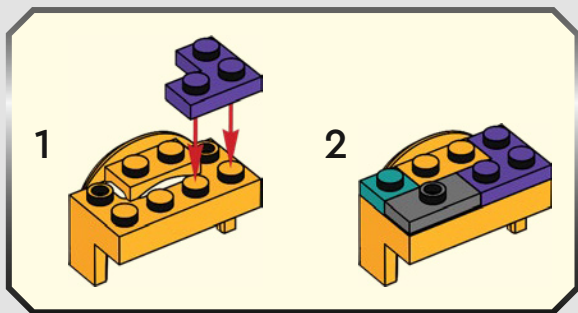

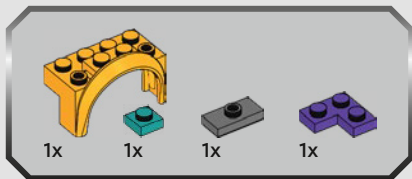

73

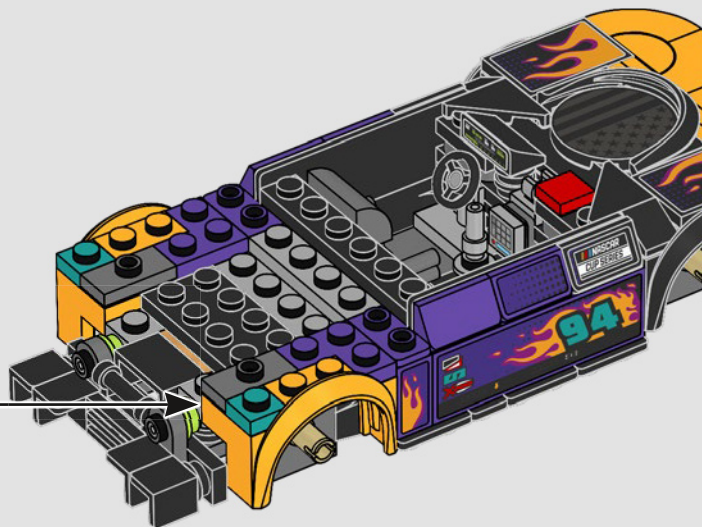
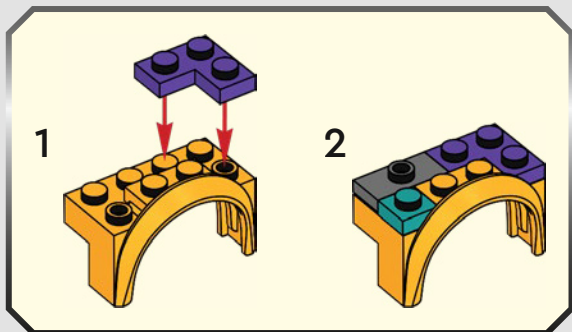



2x

74

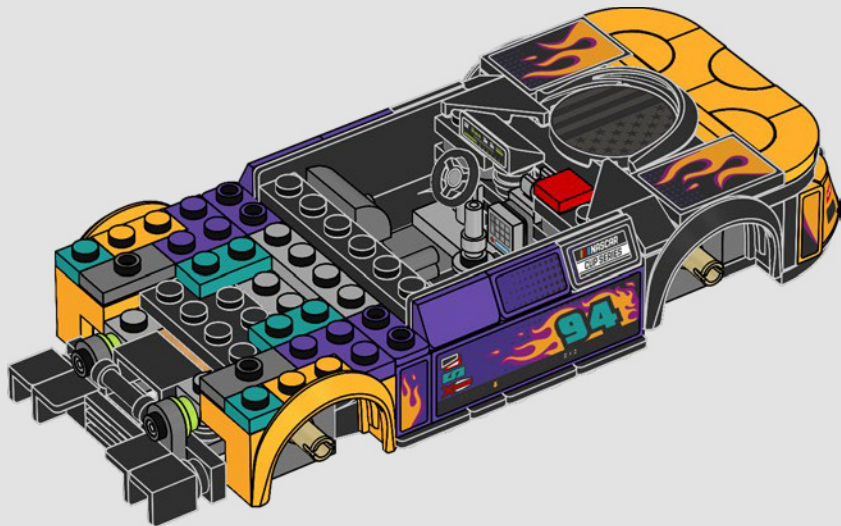

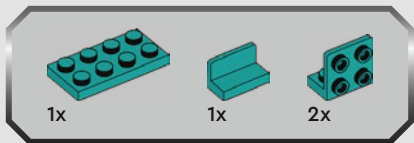

75

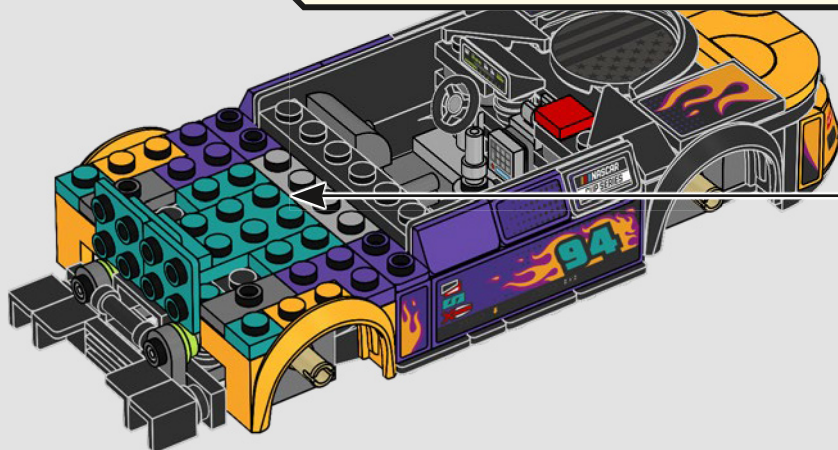
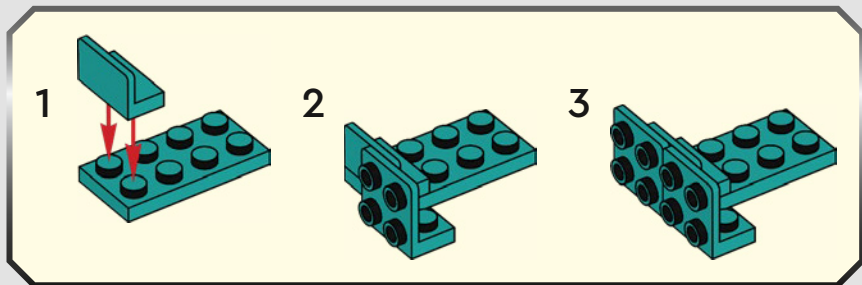

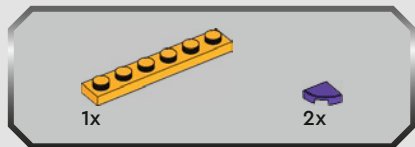

76

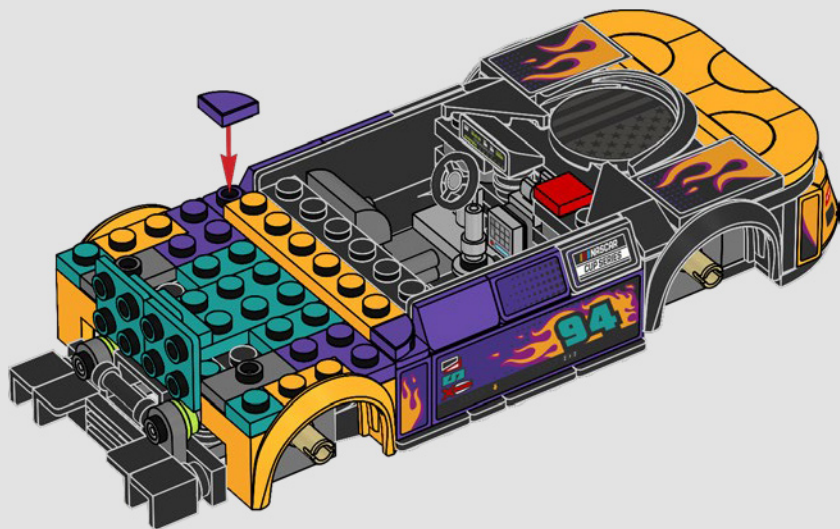



77

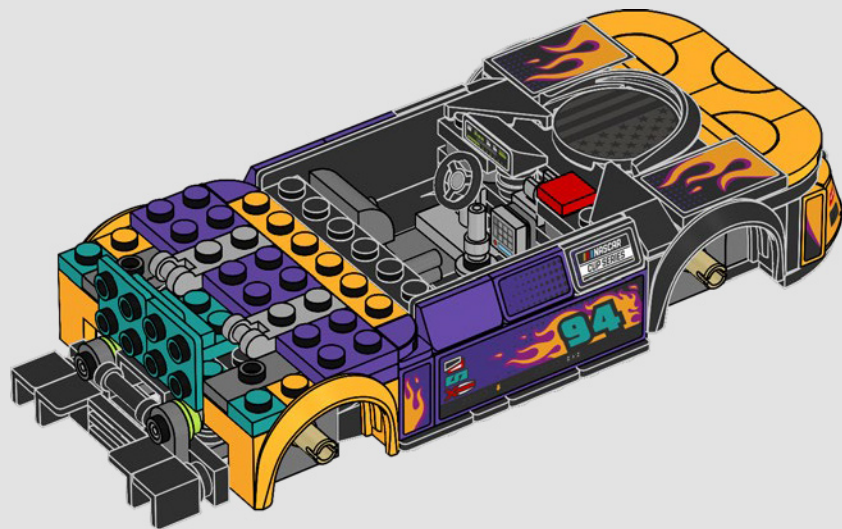



78

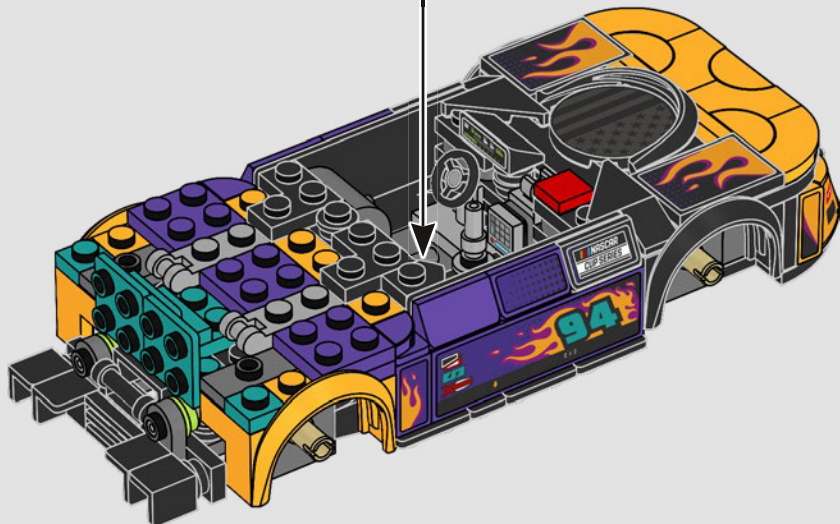



2x

79

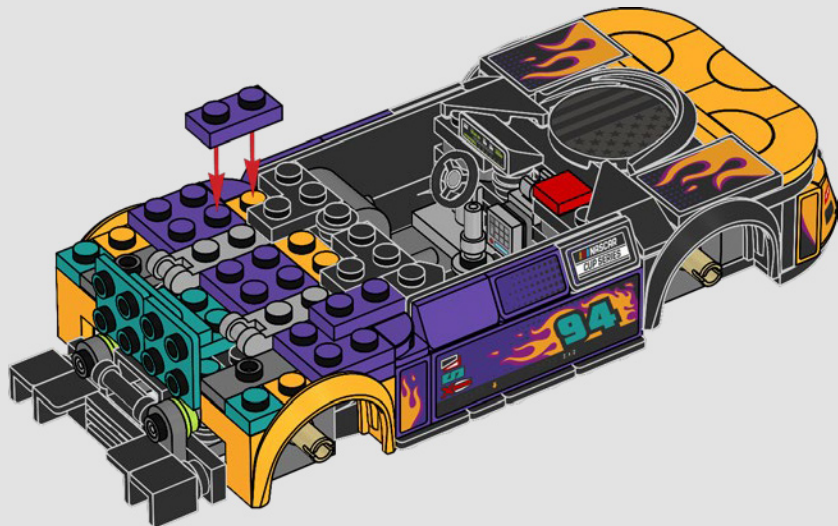

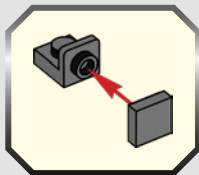
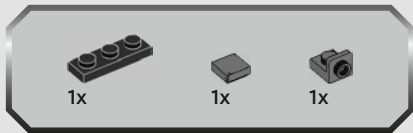

80

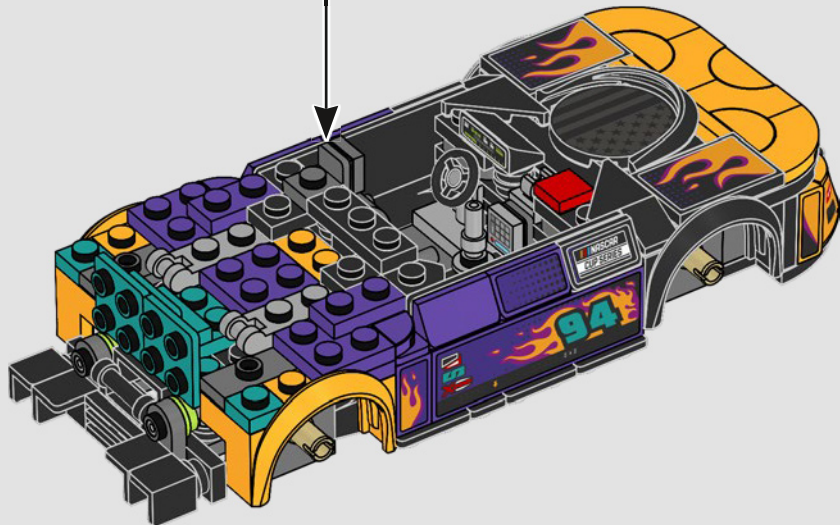

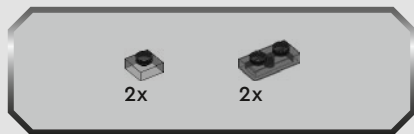

81

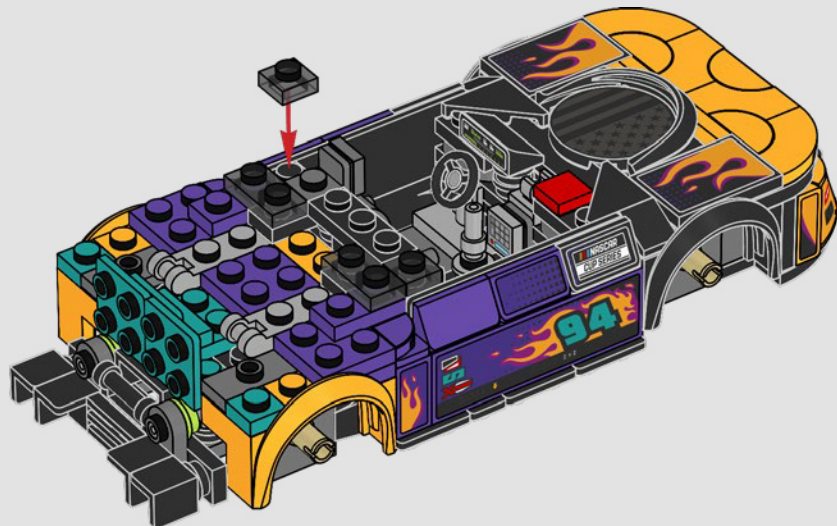

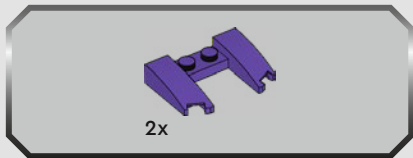

82

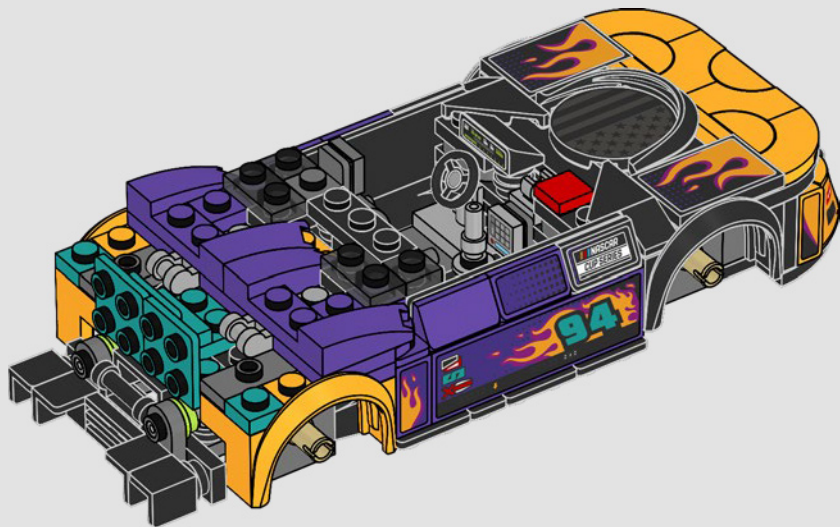

83

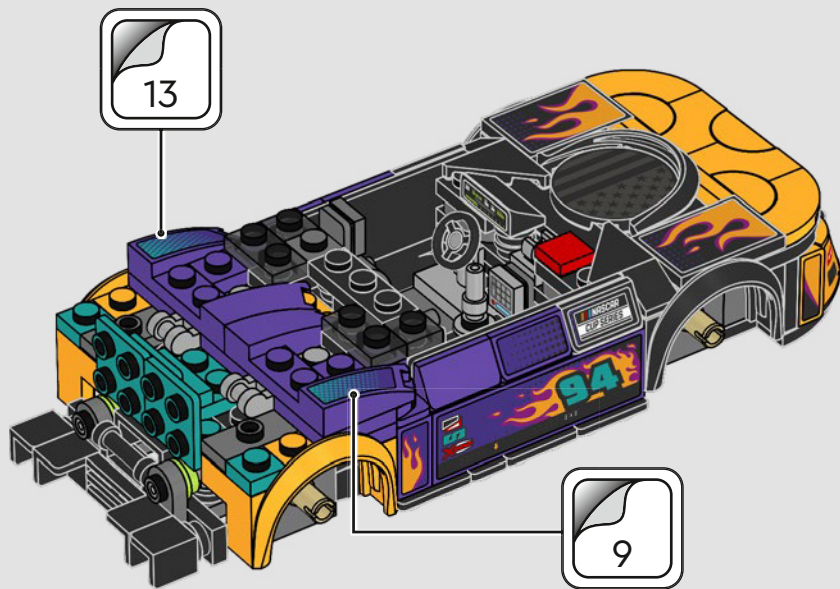



2x

84

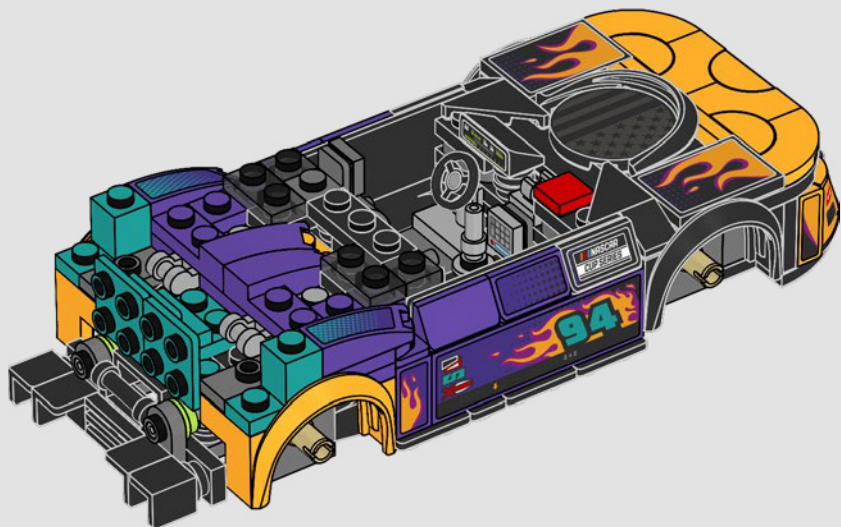



85

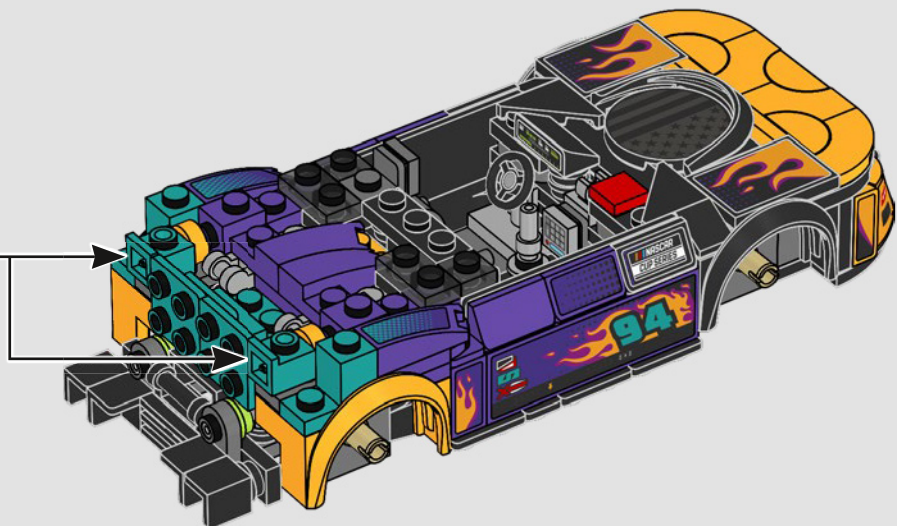
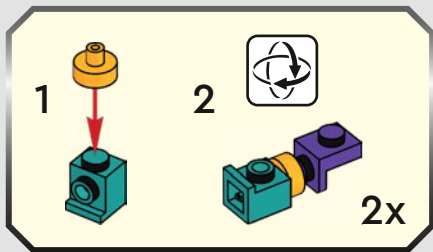



3x

86

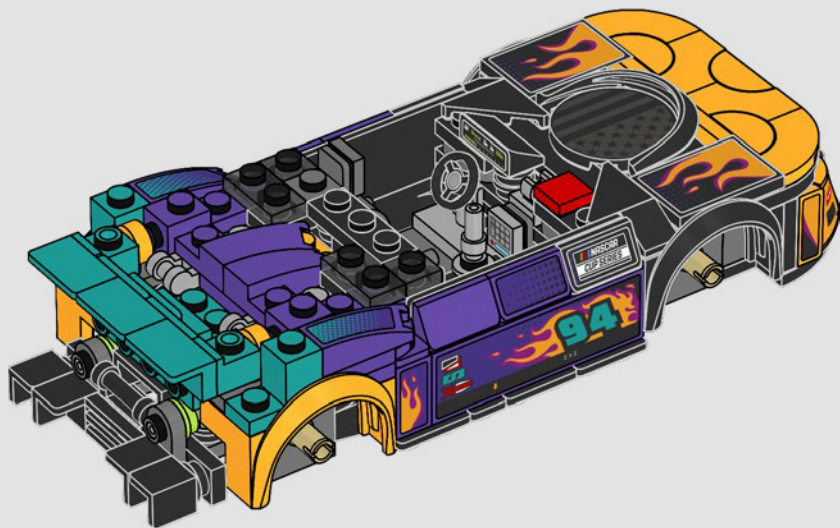



2x



2x

87

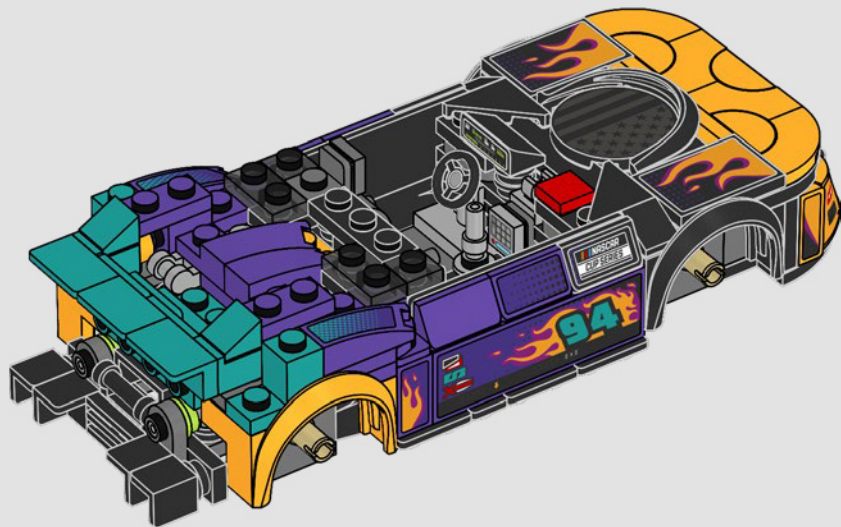

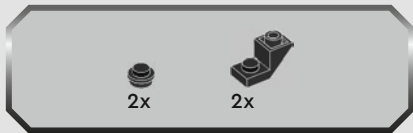

88

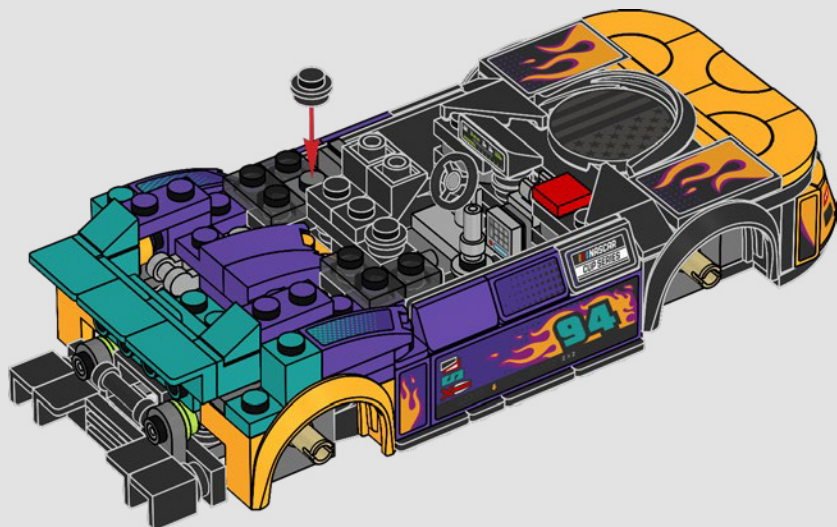



2x

89

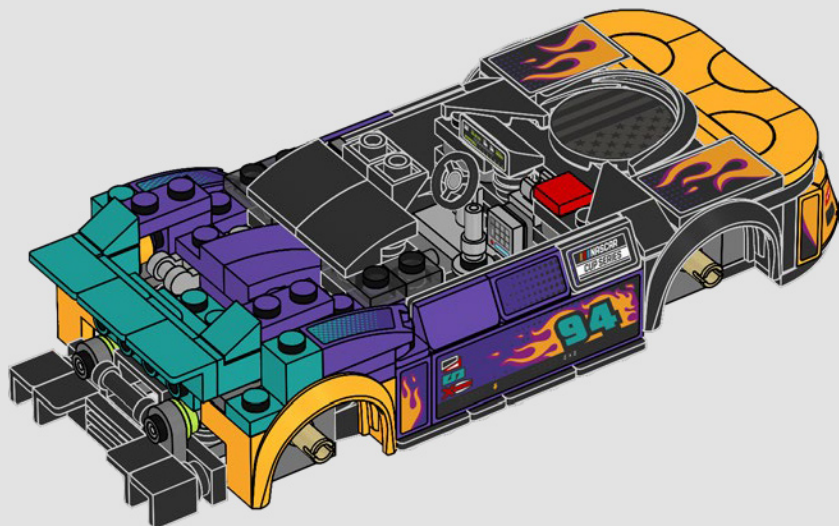



2x



2x

90

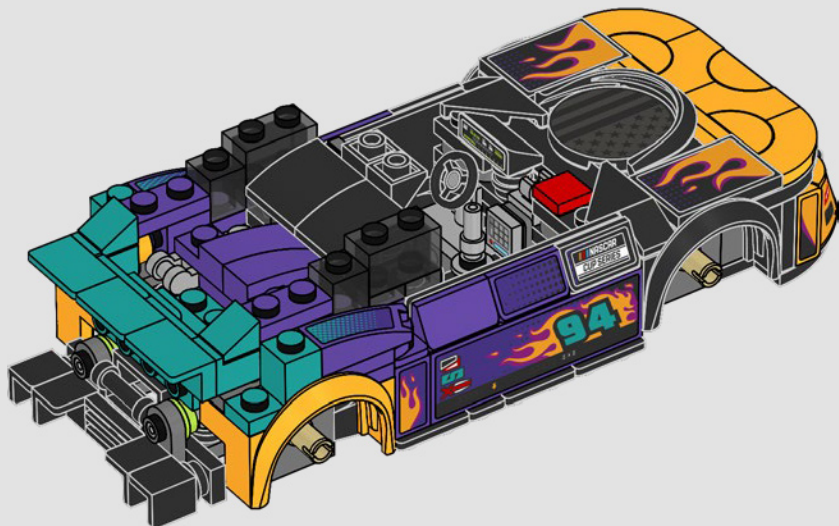

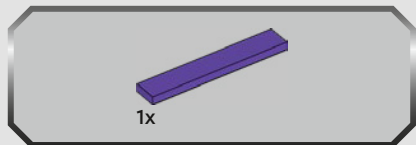

91

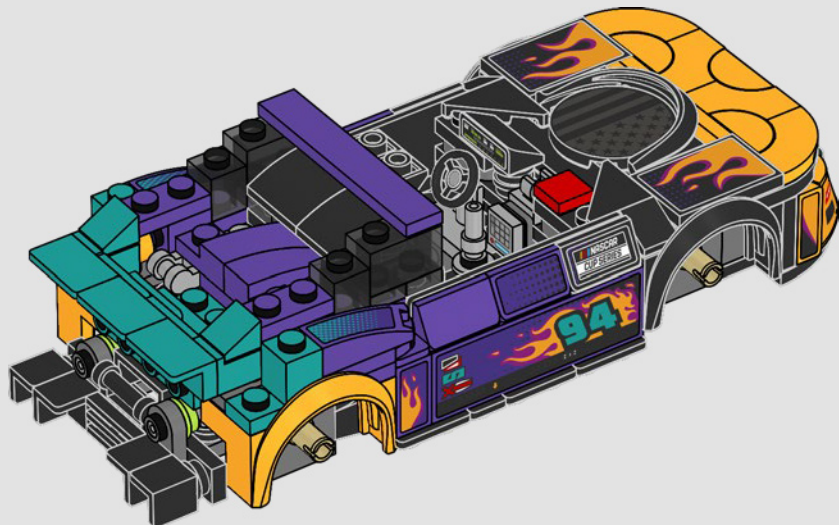

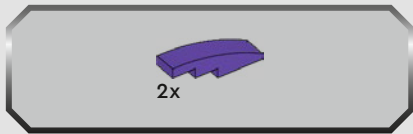

92

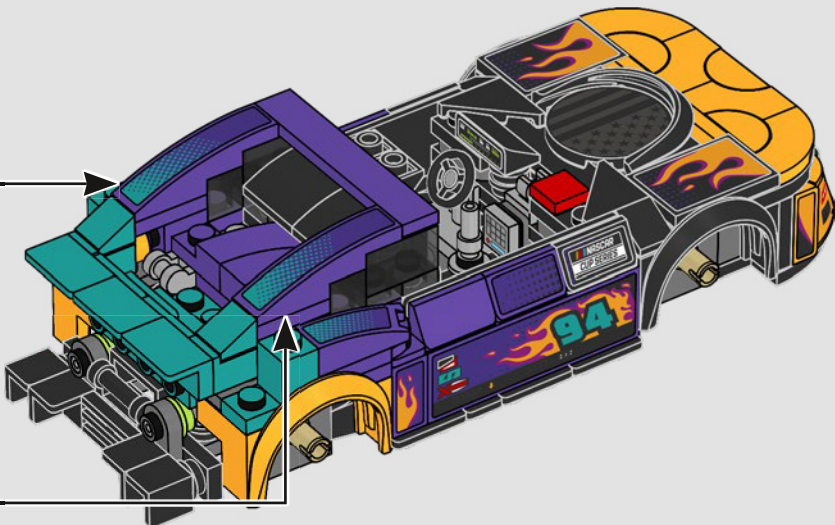
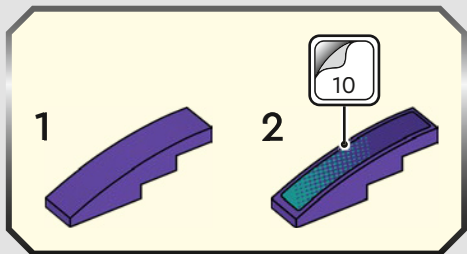
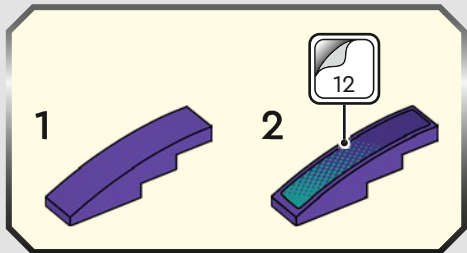



93

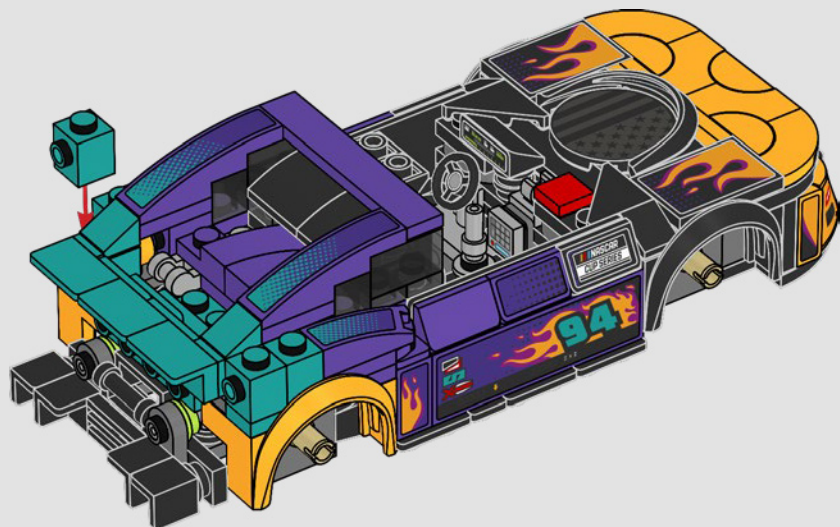

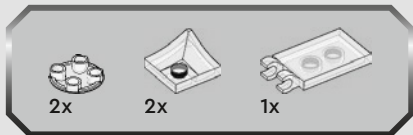

94

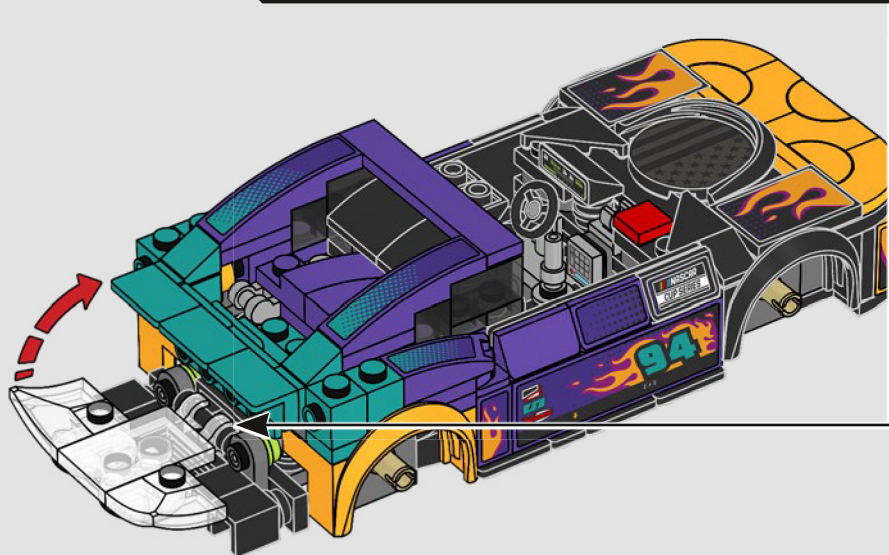
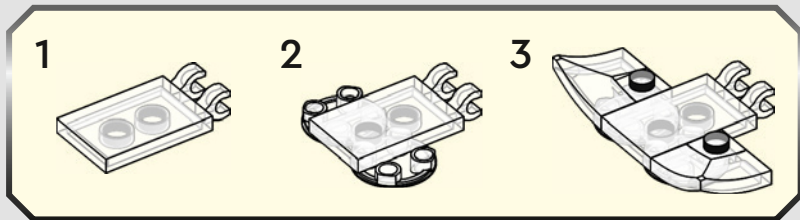

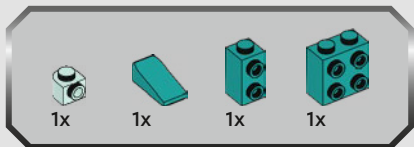

95

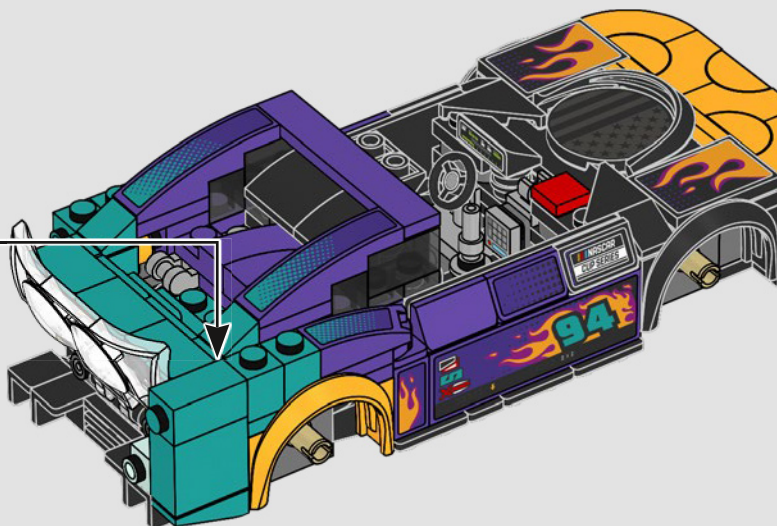
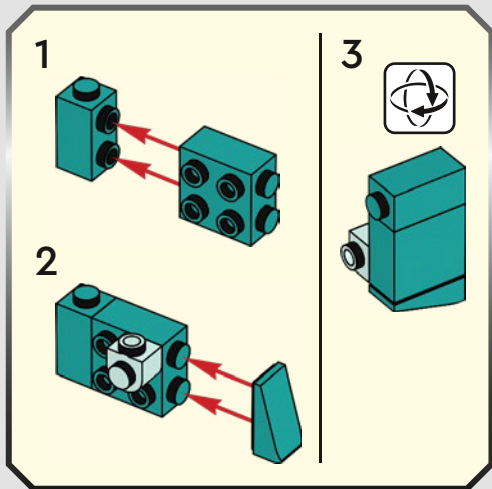

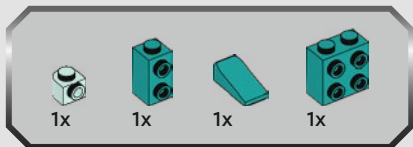

96

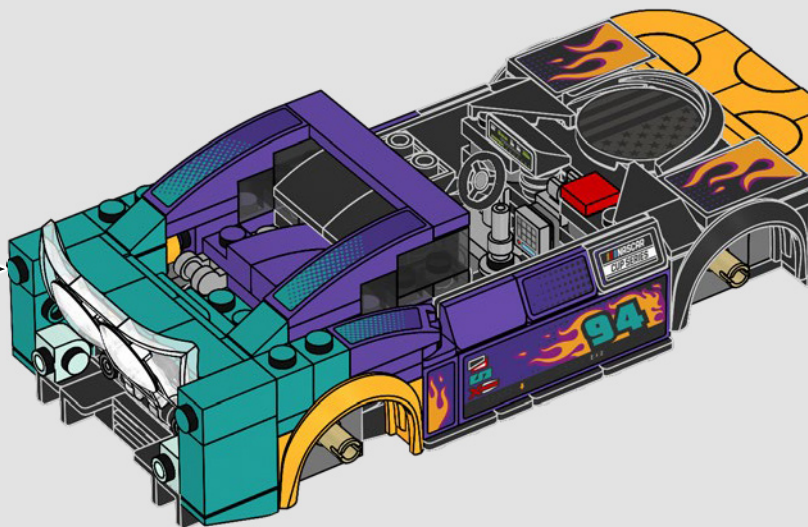
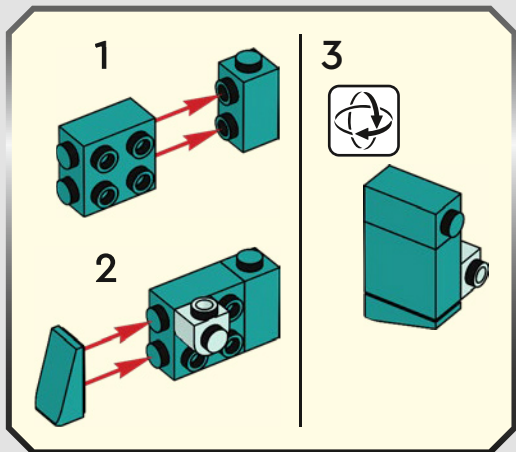

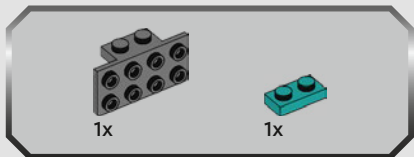
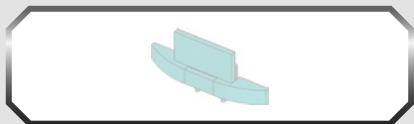

97

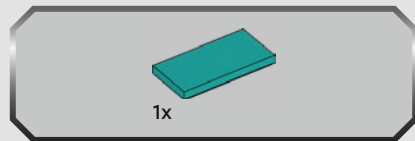
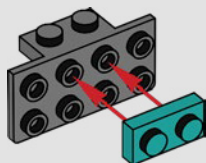

98

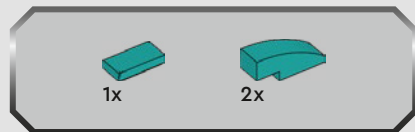
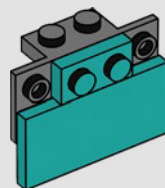

99

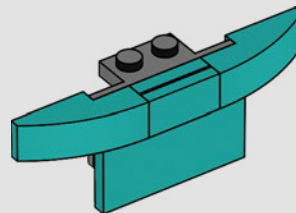



100

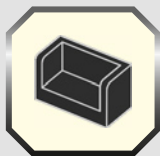
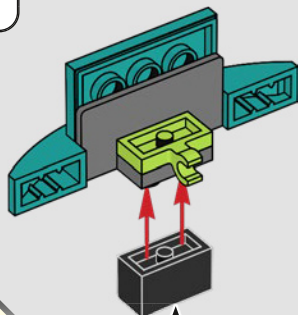

101

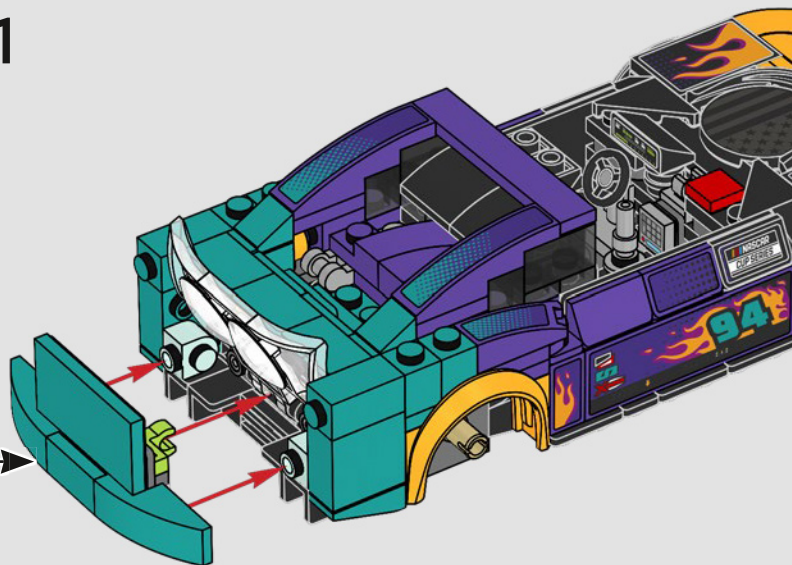

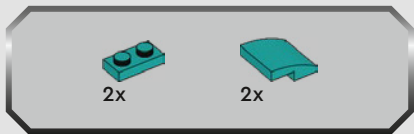

102

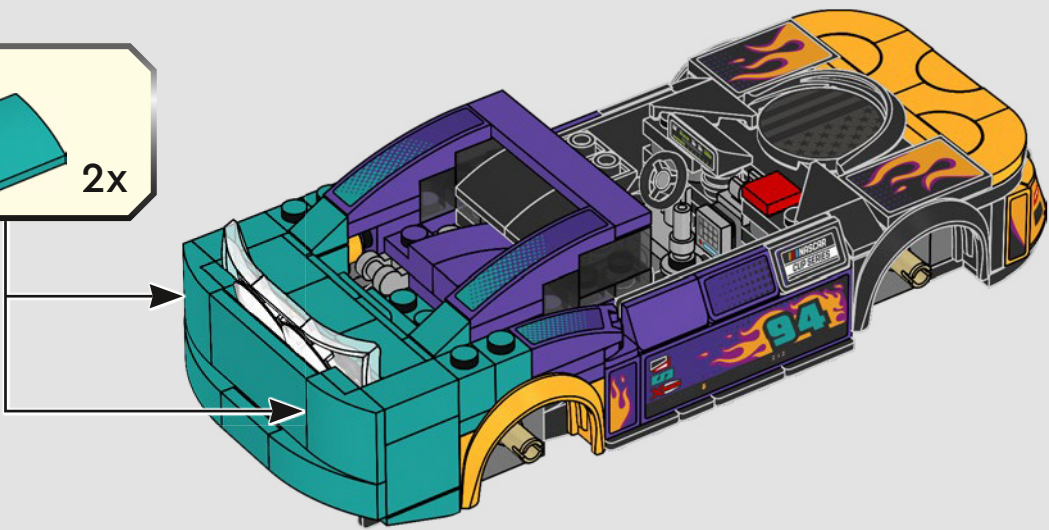
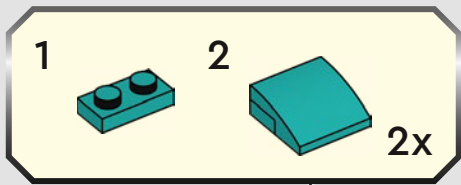

103

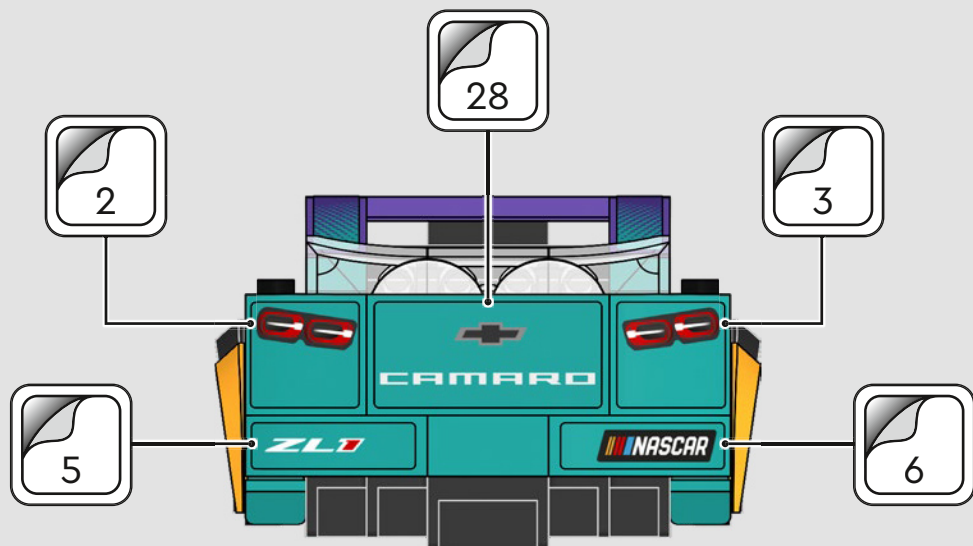

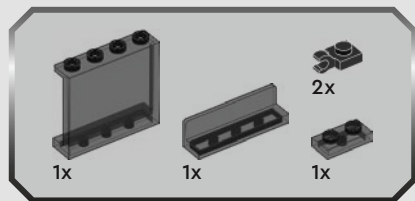

104

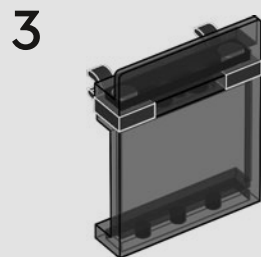
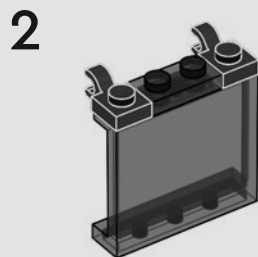
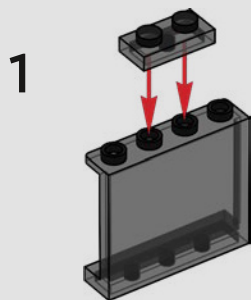

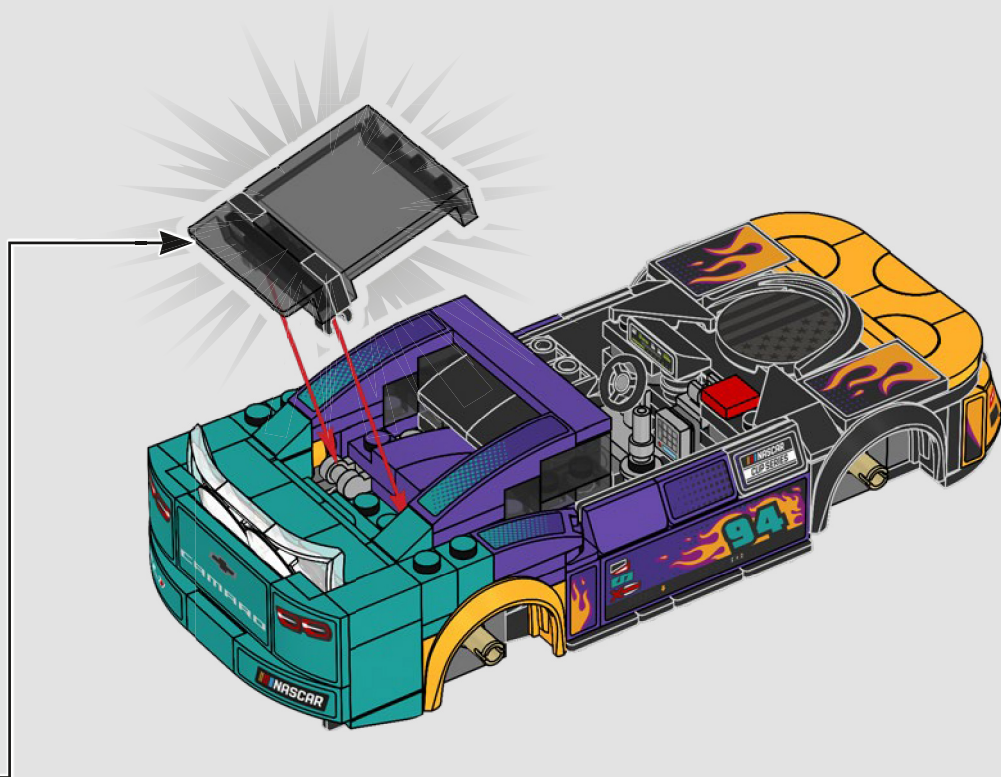

105

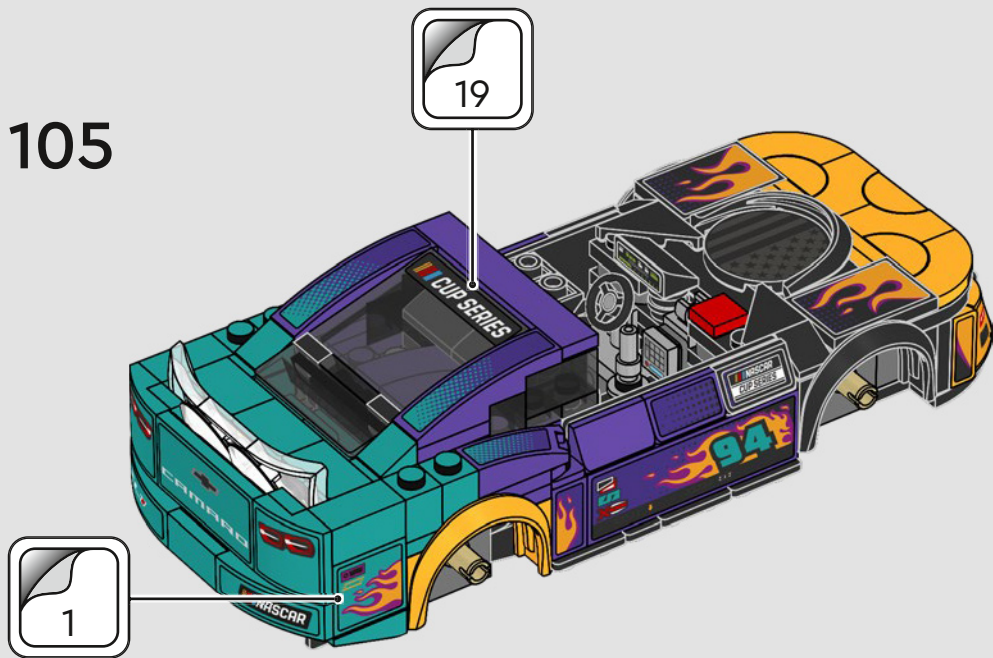

106

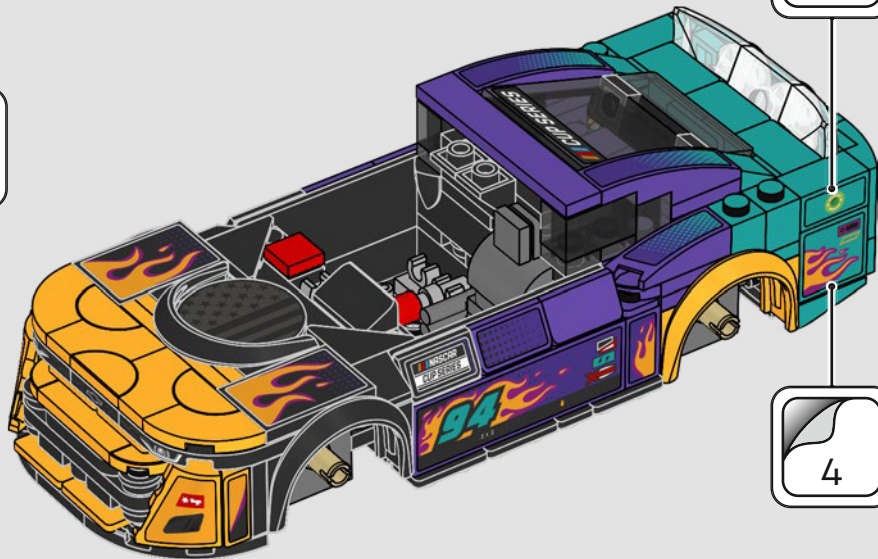



107

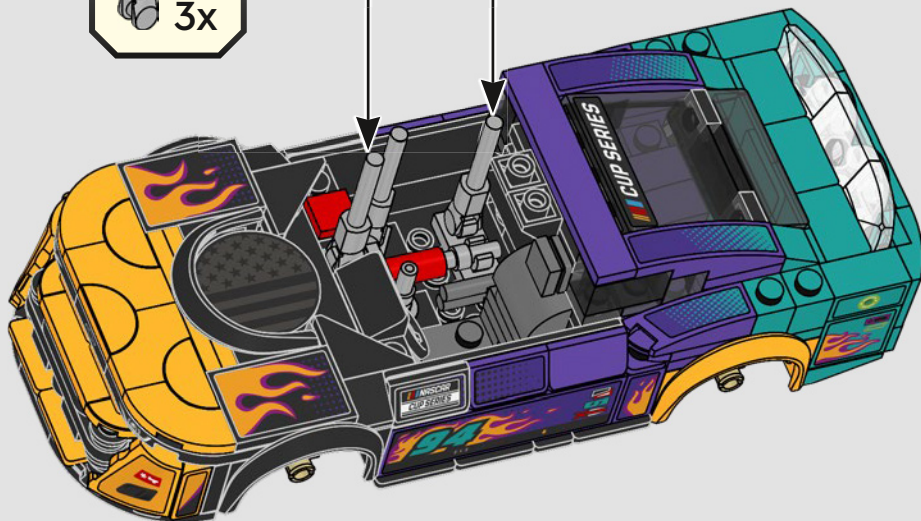
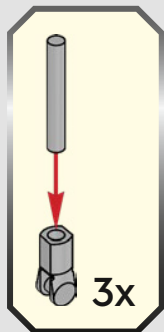

108

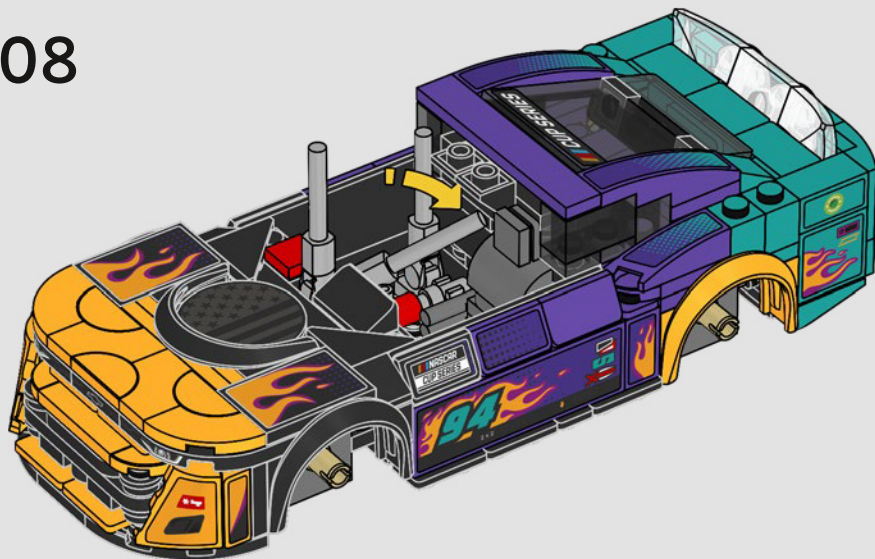

109

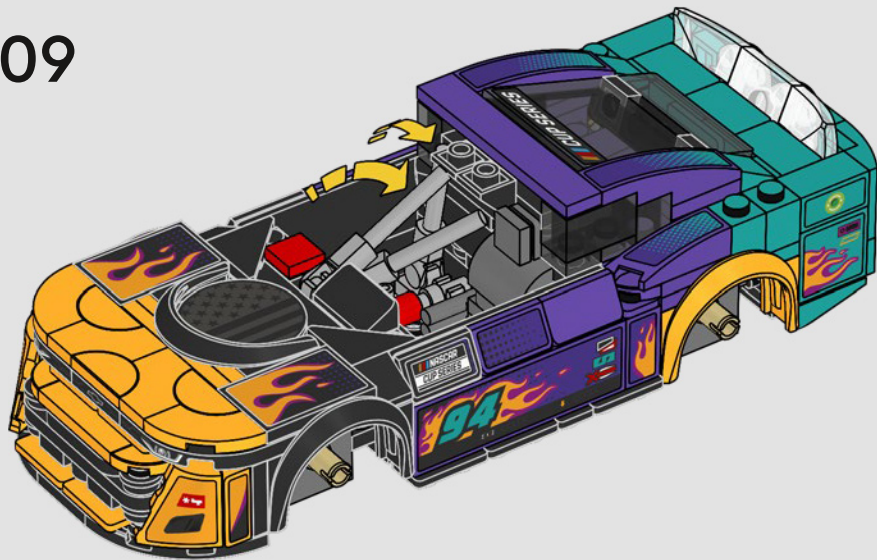

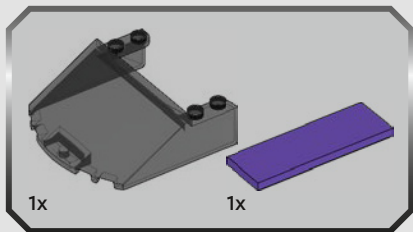

110

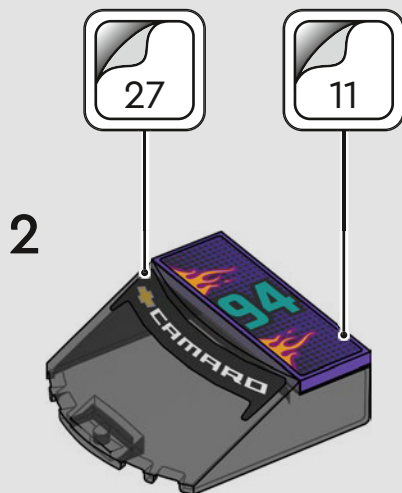
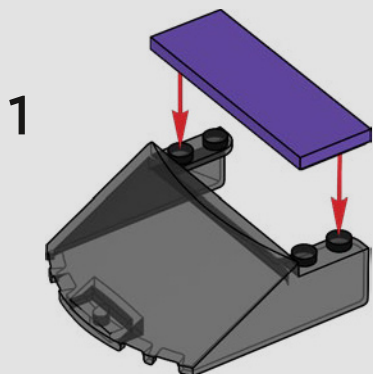

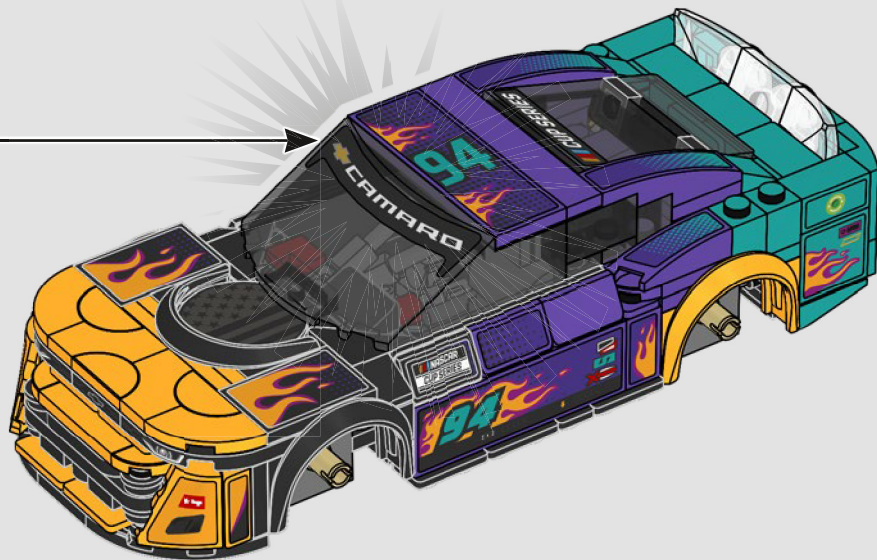

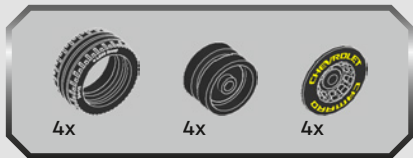

111

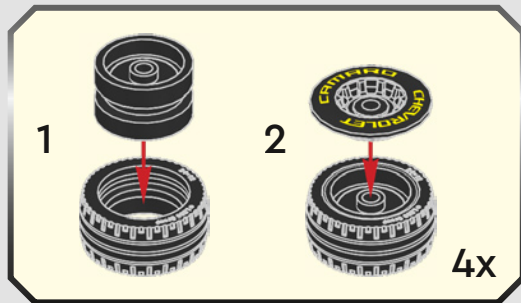
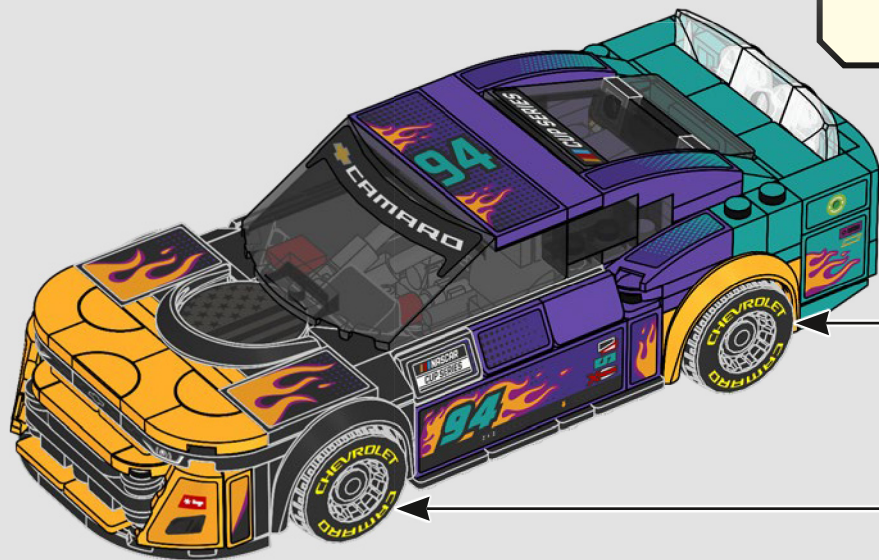

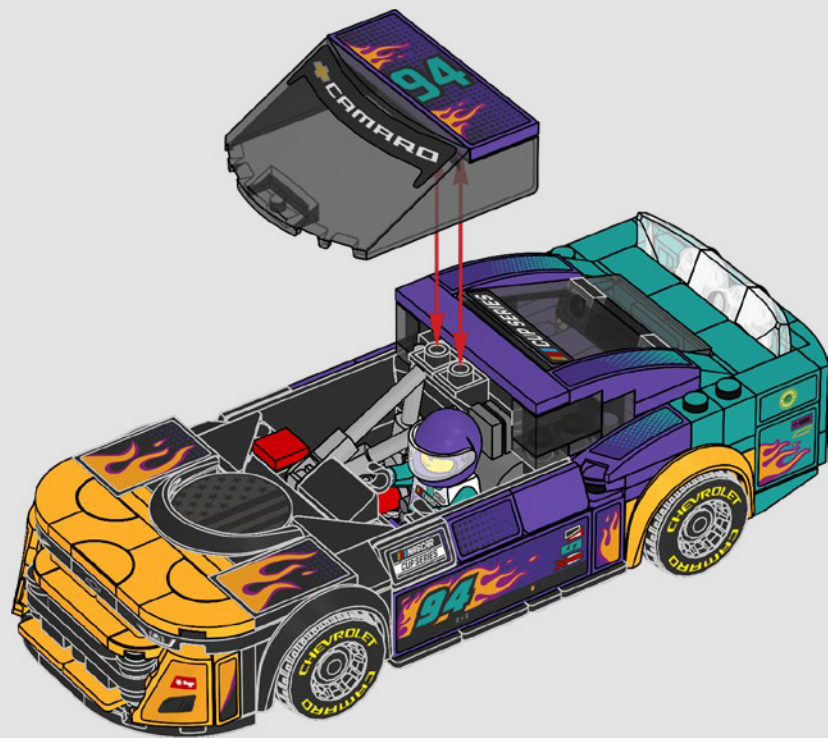

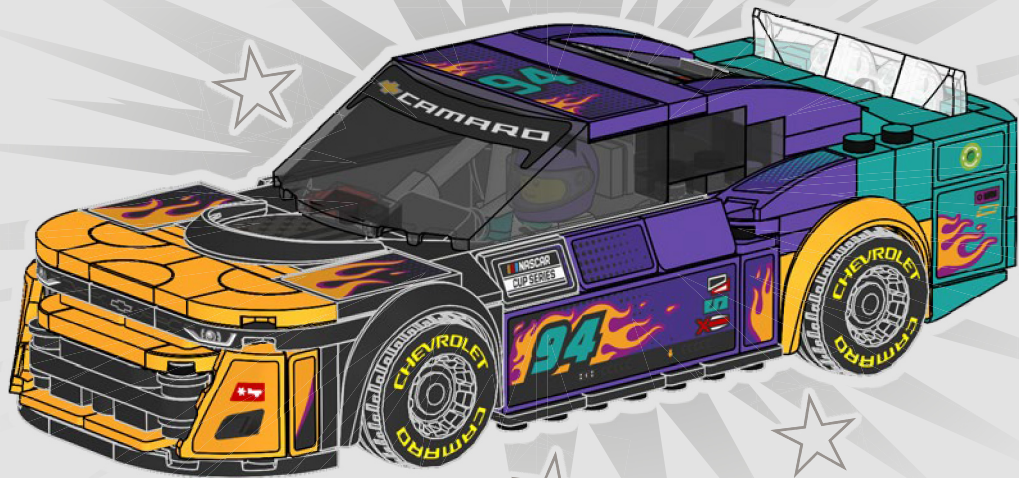



SPEED CHAMPIONS



76924

//////AMG



76923



76934



76935

//////NASCAR















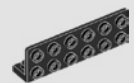







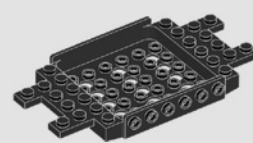





























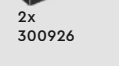















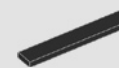

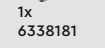





The "Lamborghini" and "Lamborghini Bull and Shield" trademarks, copyrights, designs and models are used under license from Automobili Lamborghini S.p.A, Italy.

//////AMG, „Mercedes-Benz" and "Three-pointed star in a ring" are the intellectual property of Mercedes-Benz Group AG. They are used by The LEGO Group under license.

Produced under license of Ferrari S.p.A. The name FERRARI, the PRANCING HORSE device, all associated logos and distinctive designs are property of Ferrari S.p.A. The body designs of the Ferrari cars are protected as Ferrari S.p.A. property under design, trademark and trade dress regulations.

General Motors Trademarks used under license to the LEGO Group.
NASCAR® is a registered trademark of the National Association for Stock Car Auto Racing, LLC.

 1x 6516934	 1x 6173959	 2x 6465248	 1x 6513799	 1x 6280168	 2x 6458186	 2x 6325978	 4x 6491442
 4x 4666579	 4x 6234695	 9x 6020193	 1x 362326	 3x 302026		 4x 6213776	 2x 6513765
 2x 6253003	 2x 6308000	 4x 6513795	 4x 6102596	 3x 6443446	 1x 6424673	 2x 6491443	 1x 6213779
 1x 6348148	 3x 4548180	 2x 6214807	 2x 6162892	 1x 6105963	 3x 6343976	 2x 6278172	 2x 6513766
 1x 307021	 1x 4226995	 1x 6428168	 1x 6331483	 2x 300926	 3x 6168647	 2x 6439825	 2x 6223665
 1x 4651441	 2x 6248496	 1x 4225201	 2x 243126	 2x 366626	 1x 6329583	 2x 6213781	 2x 6249426
 16x 614126	 3x 6092585	 4x 6290263	 1x 6513796	 2x 366626	 4x 6308012	 2x 6213778	 1x 6338181
 1x 6186675	 1x 6513797	 8x 242026	 1x 6513798	 1x 663626	 2x 6436419	 2x 6533890	 1x 6223065
 2x 4504382	 2x 241226	 2x 6053077	 2x 6434275	 3x 6093527	 2x 6436419	 2x 6508337	 1x 6223065
 4x 4106347	 2x 393726	 2x 302226		 1x 6513771	 1x 6513771	 12x 6213777	

2x
6190251

1x
6334046

2x
6223719

2x
6073040

2x
6214457

2x
6433937

3x
6513772

2x
6024286

1x
6513763

1x
6513764

2x
6122504

2x
6445339

2x
6134634

2x
6334203

2x
6498126

1x
6099725

2x
6513762

3x
6020074

1x
6112609

1x
4210848

2x
4558955

2x
6388133

2x
6225494

15x
6221607

2x
6092572

2x
6176400

1x
6302690

1x
6309059

2x
6411395

1x
6343852

2x
4211133

1x
6118832

2x
4263176

2x
6454959

2x
6199891

2x
6336391

2x
6513770

1x
6518240

4x
4566607

1x
4586410

4x
4655695

2x
4613192

4x
6047422

2x
6167461

2x
6513769

2x
6513768

1x
4619657

3x
6513767

2x
6493687

1x
6167576

4x
6469825

4x
6470140

2x
6446336

3x
6514010

2x
6513761

1x
6499904

1x
6467819

1x
6510197

 [LEGO.com/service](https://www.LEGO.com/service)



YOU COULD
WIN



Scan this QR code or go to
LEGO.COM/PRODUCTFEEDBACK and give us
your short feedback about this LEGO® set for
a chance to win a cool LEGO prize.

Terms and Conditions apply*

EN: YOU COULD WIN. Terms and Conditions apply* **DE: Du könntest GEWINNEN.** Es gelten die Teilnahmebedingungen* **FR: Tu pourrais GAGNER.** Des conditions s'appliquent* **IT: Potresti VINCERE tu.** Termini e condizioni sono applicabili* **ES: Puedes GANAR.** Aplican términos y condiciones* **PT: Poderá GANHAR.** Aplicam-se termos e condições* **ZH: 轻松获奖. 条款和条件适用*** **PL: Szansa na WYGRANĄ.** Obowiązują warunki korzystania* **CS: Máte šanci VYHRÁT.** Platí všeobecné smluvní podmínky* **SK: Máte šancu VYHRÁŤ.** Platia všeobecné zmluvné podmienky* **HU: TE IS NYERHETSZ.** Felhasználási feltételek érvényesek* **RO: Ai putea CÂȘTIGA.** Se aplică termenii și condiții* **BG: Можете да СПЕЧЕЛИТЕ.** Има определени правила и условия* **LV: Tu vari LAIMĒT.** Ir spēkā noteikumi un nosacījumi.* **ET: Sul on võimalus VÕITA.** Kehtivad tingimused* **LT: Jūs galite LAIMĖTI.** Taikomos sąlygos*

*[LEGO.com/productfeedback/terms](https://www.lego.com/productfeedback/terms)

LEGO and the LEGO logo are trademarks of the/son des marques de commerce du/son marcas registradas de LEGO Group. ©2024 The LEGO Group.

General Motors Trademarks used under license to the LEGO Group.

NASCAR® is a registered trademark of the National Association for Stock Car Auto Racing, LLC.

6546543