



DREAMZZZ

71471



Q LEGO® Builder



Get excited about our new packaging!

We're switching from plastic to paper-based packaging. That's why you might find a mix of paper and plastic in our boxes!

Nos nouveaux emballages vous emballeront !

Nous passons des emballages en plastique aux emballages à base de papier. C'est pourquoi vous pourriez trouver un mélange de papier et de plastique dans nos boîtes !

¡Te presentamos nuestros nuevos empaques!

Estamos sustituyendo las bolsas de plástico por bolsas con base de papel. ¡Por eso, puedes encontrar una mezcla de papel y de plástico en nuestras cajas!

[LEGO.com/sustainable-packaging](https://www.lego.com/sustainable-packaging)



Q LEGO® Builder

BUILDER



Apple and the Apple logo are trademarks of Apple Inc., registered in the U.S. and other countries and regions. App Store is a service mark of Apple Inc. Google Play and the Google Play logo are trademarks of Google LLC. Tencent and the Tencent logo are trademarks of Tencent Inc.

Q LEGO.com/devicecheck

EN Ask parents' permission before going online | **DE** Eltern um Erlaubnis bitten, bevor du online gehst | **FR** Demande l'autorisation d'un parent avant d'aller en ligne | **IT** Chiedi il permesso ai tuoi genitori prima di andare online | **ES** Pídeles permiso a tus papás antes de conectarte a Internet | **PT** Pede autorização aos pais antes de acederes online | **ZH** 上网前应先征得父母的同意 | **PL** Poproś rodziców o zgodę, zanim wejdiesz do Internetu | **CS** Než půjdeš na internet, požádej rodiče o svolení | **SK** Skôr než pôjdeš na internet, vypýtaj si povolenie od rodičov | **HU** Kérj szülői engedélyt, mielőtt online csatlakoznál! | **RO** Cere permisiunea părinților înainte de a te conecta online | **BG** Поискайте разрешение от родител, преди да влезете онлайн | **LV** Pirms došanās tiešsaistē palūdz atļauju vecākiem | **ET** Enne Interneti kasutamist küsi vanematelt luba | **LT** Prieš prisijungdami prie interneto, atsiklauskite tėvų









1x



1x

1

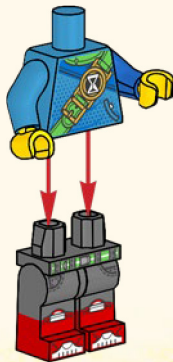



1x



1x

2

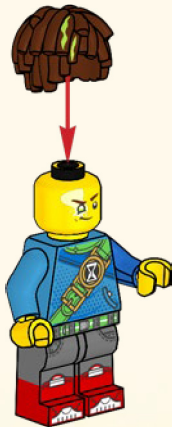

1x



1x

3

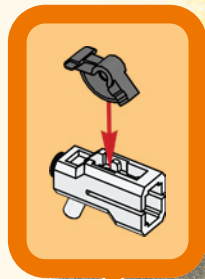



2x



1x



1x

4

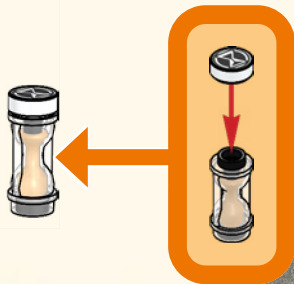
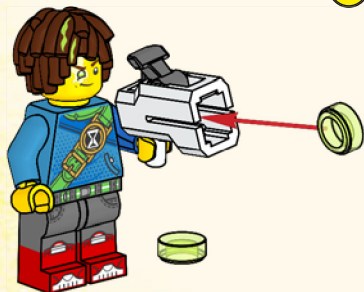
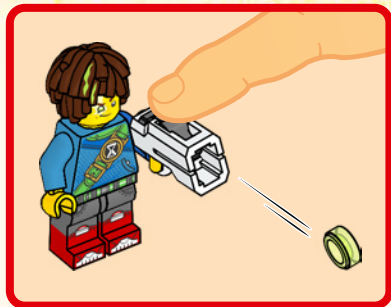



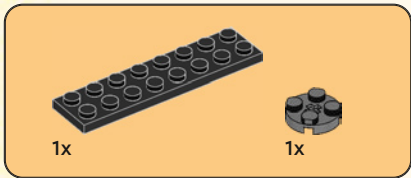
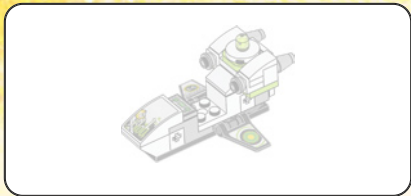

1

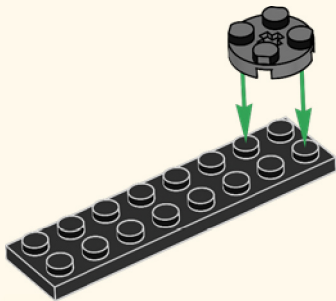



2x

2

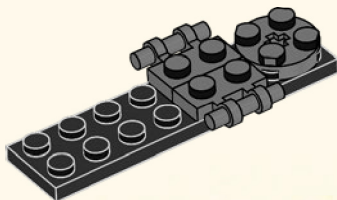



1x

3

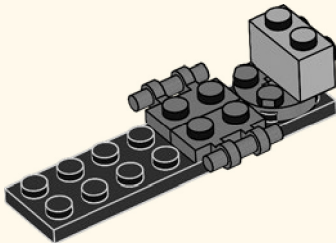



2x

4

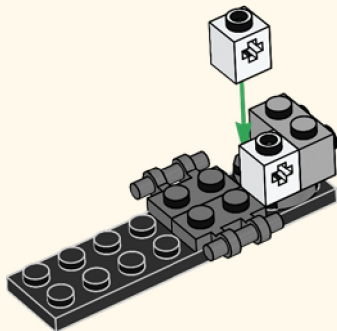



1x

5

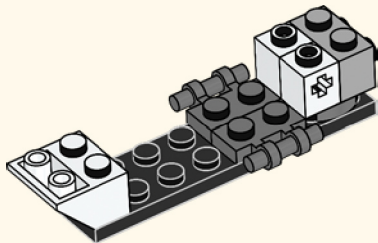



2x

6

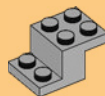
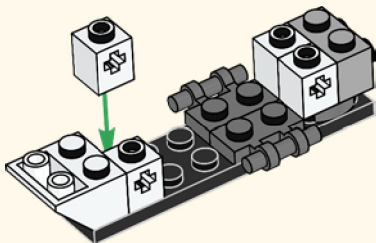

1x

7

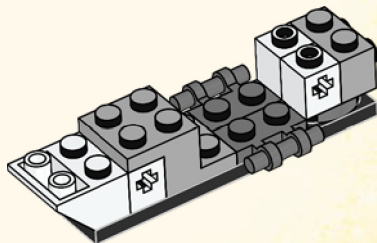

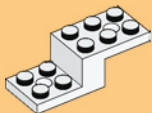

1x

8

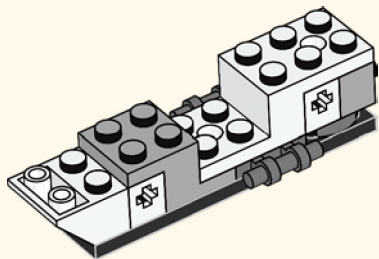

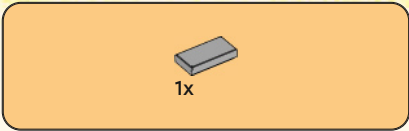

9

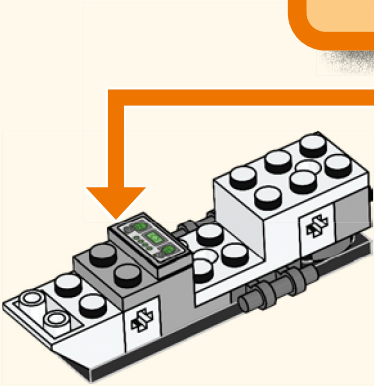
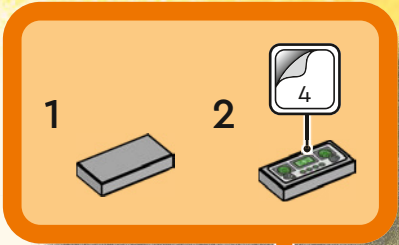



1x

10

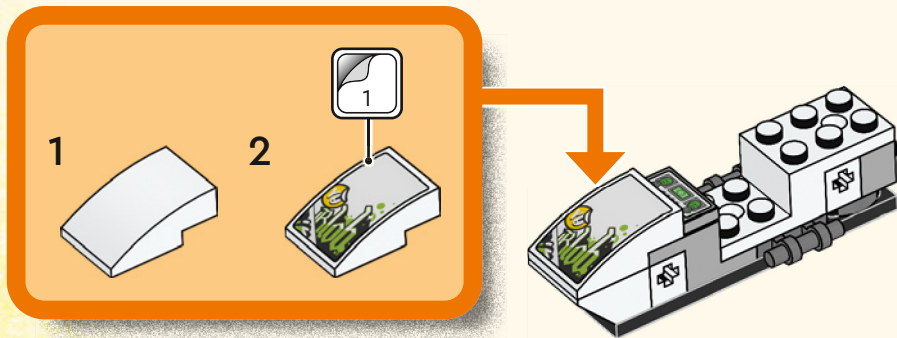



1x

11

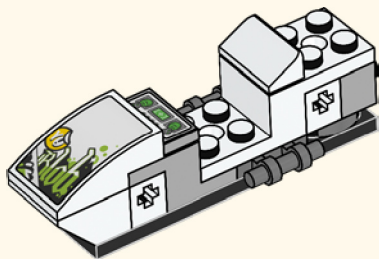

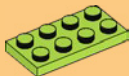

1x

12

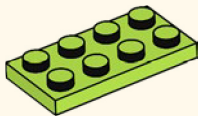



1x

13

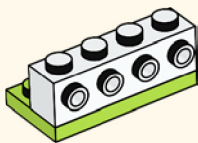



2x



1x

14

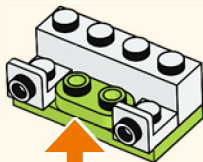



1x

15

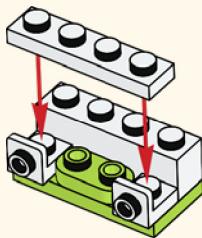



1x

16

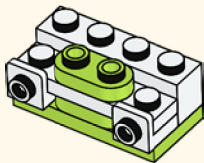



1x

17

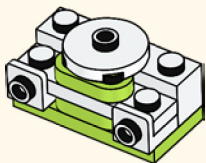

2x

18

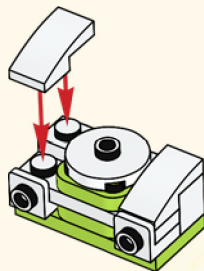



2x

19

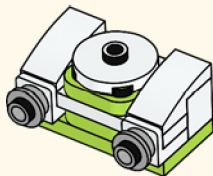

20

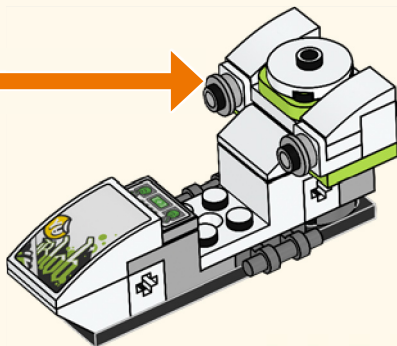



2x



1x

21

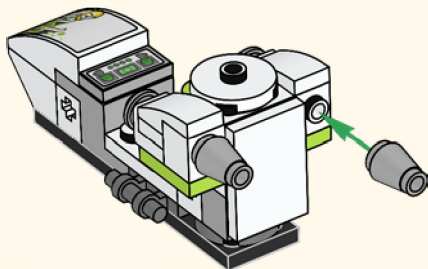



1x

22

1



2



3

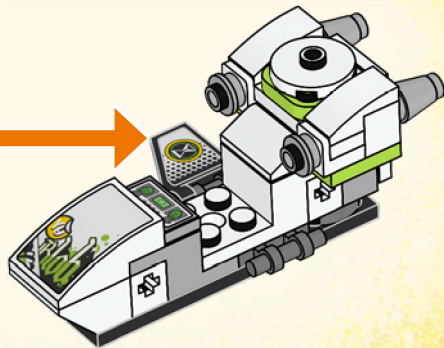



1x

23

1



2

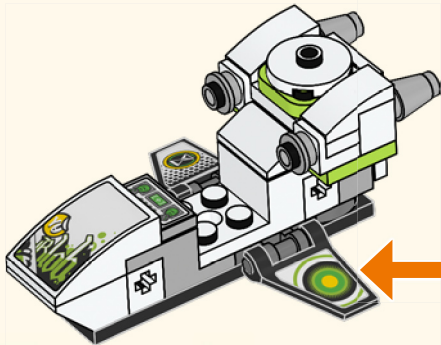



24

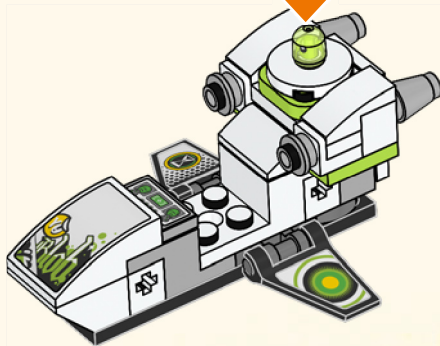



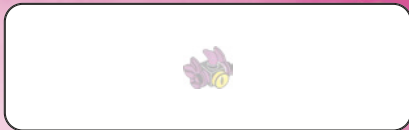

1x

1x

1





1x



2x

2

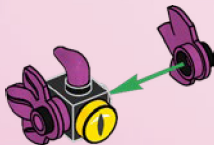

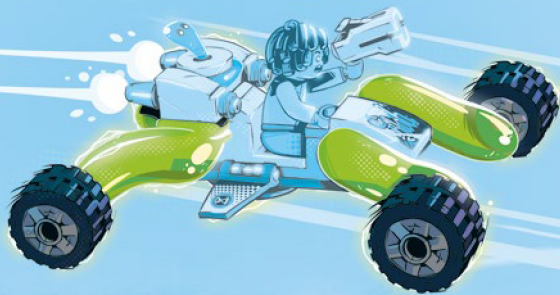

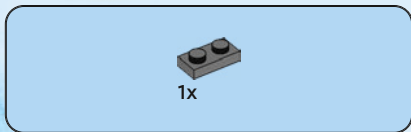

25

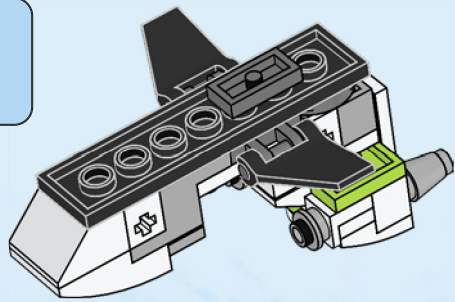



2x

26

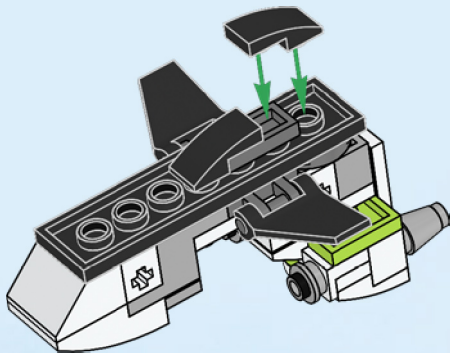

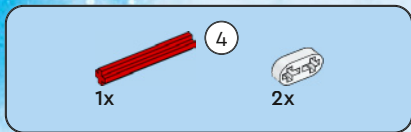

27

1



2

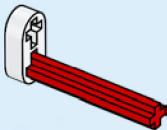

3

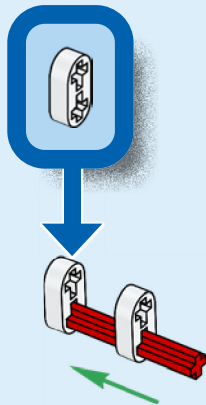

38

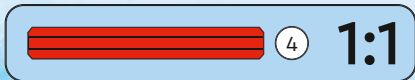

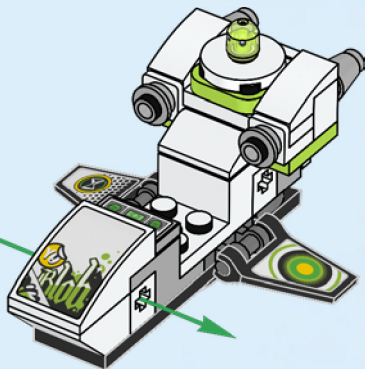
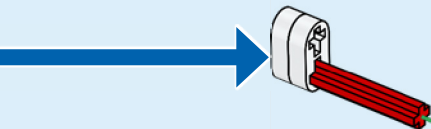



2x

28

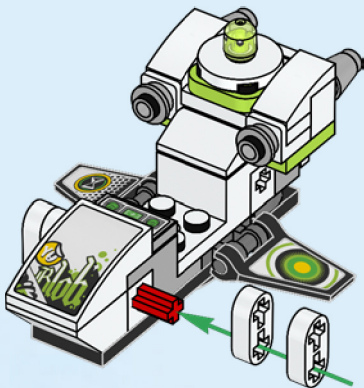



2x

29

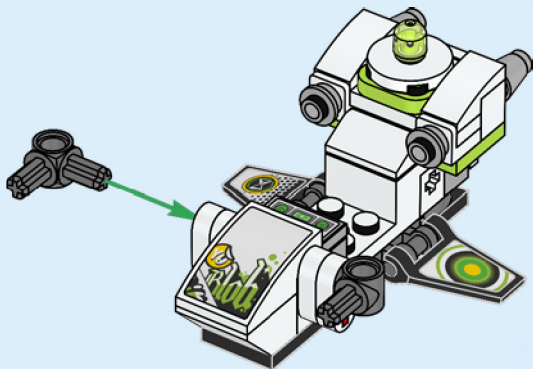

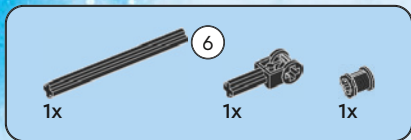

30

1



2

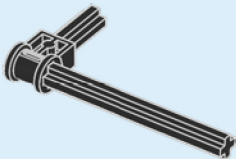

3

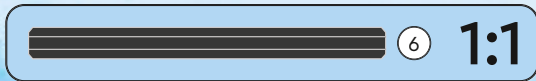
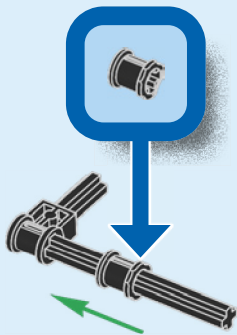

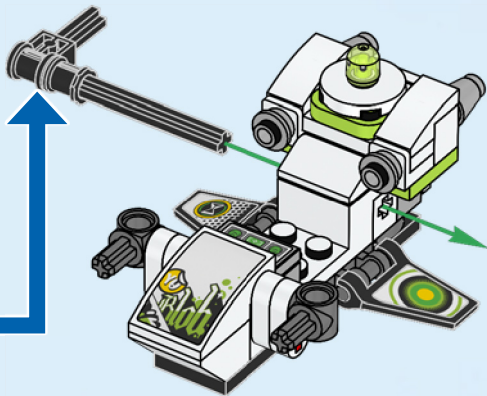



1x

31

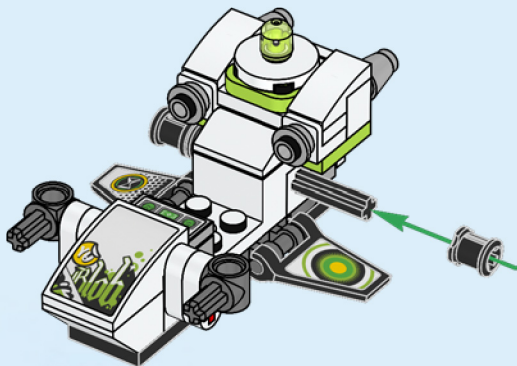



1x

32

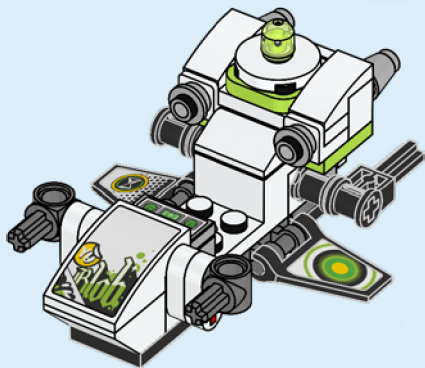



2x

33

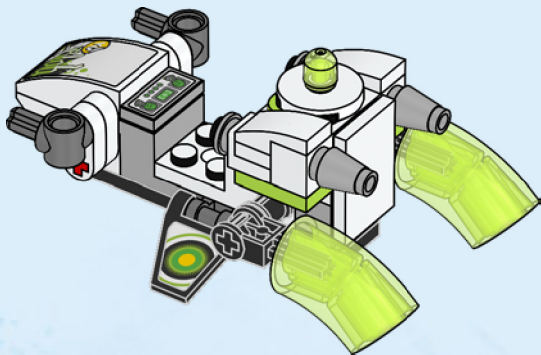



2x

34

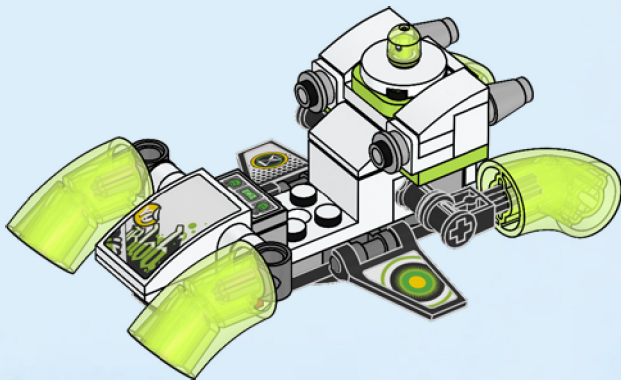



4x



1x



1x

35

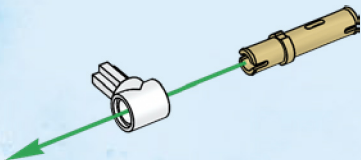

1x

36

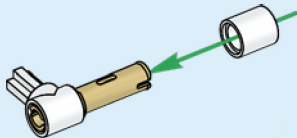

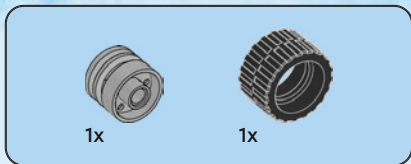

37

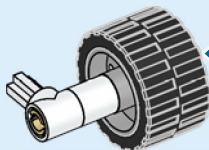
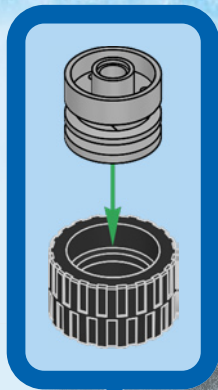

4x

38

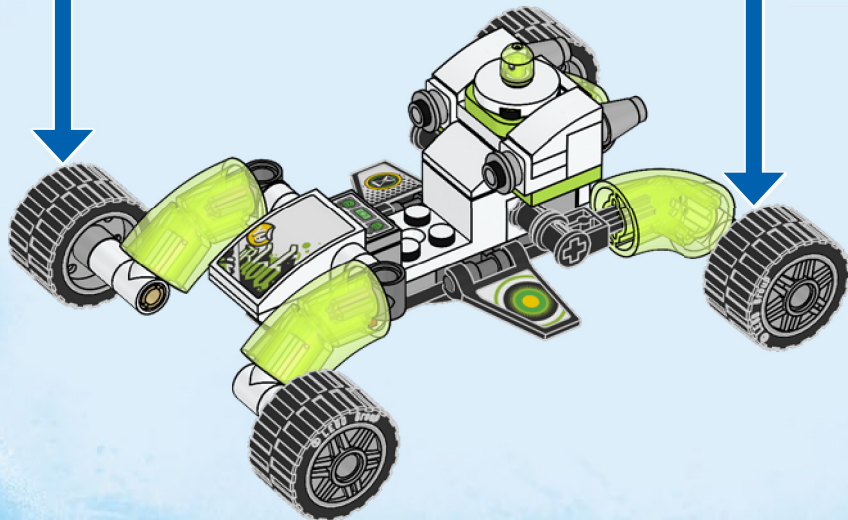

50



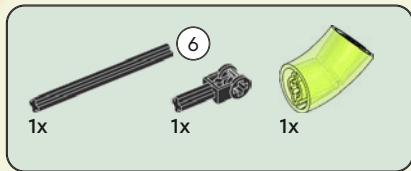

25

1

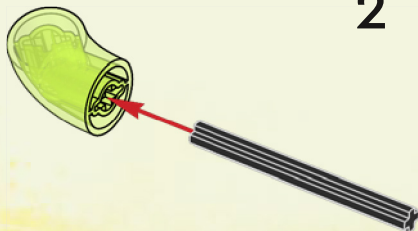

2

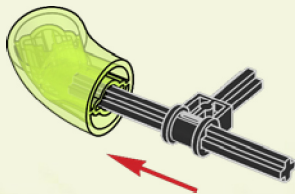

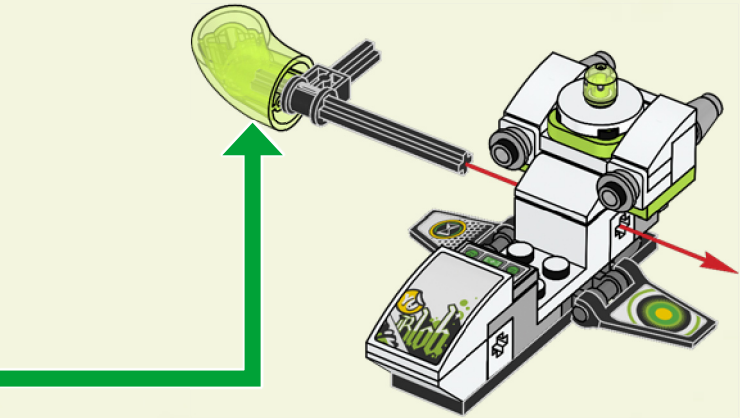



1x

26

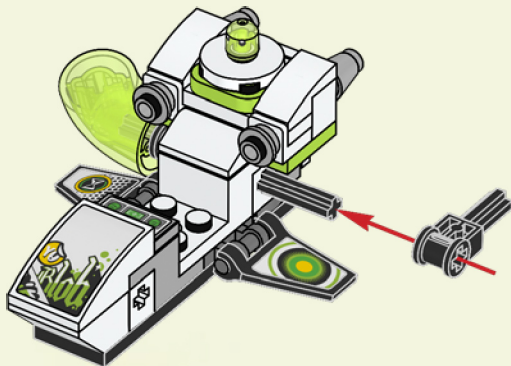



1x

27

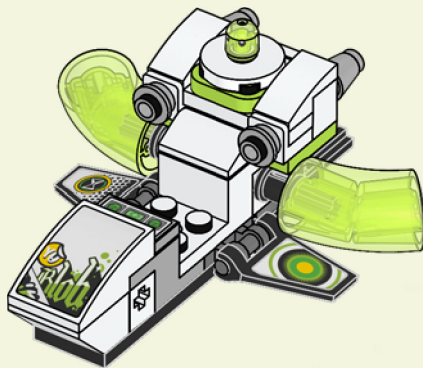



2x



2x



2x



2x

28

1

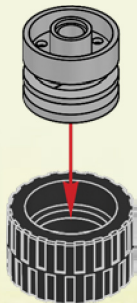

2

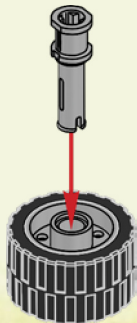

2x

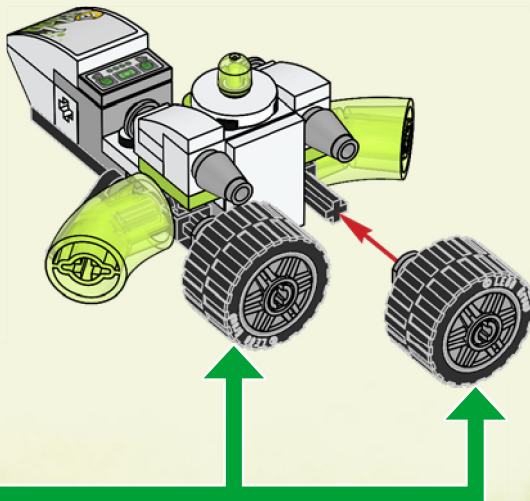

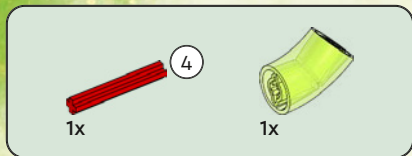

29

1



2

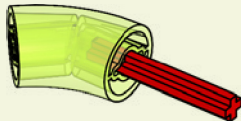

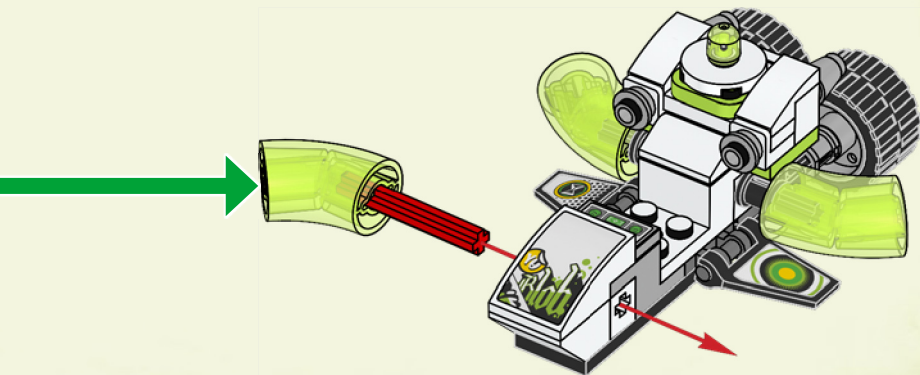



1x

30

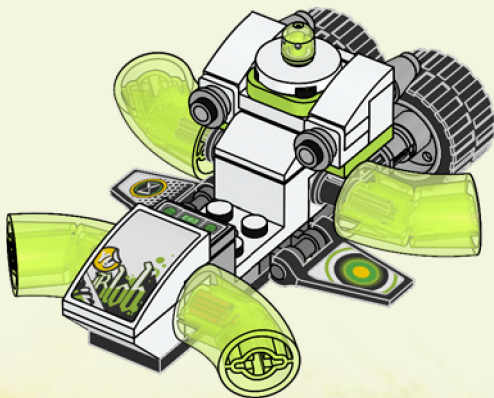



4x



4x



4x



4x



4x

31

1

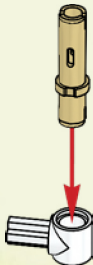

2

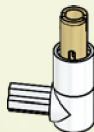

3

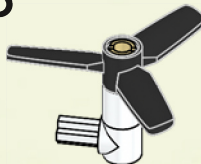

4x

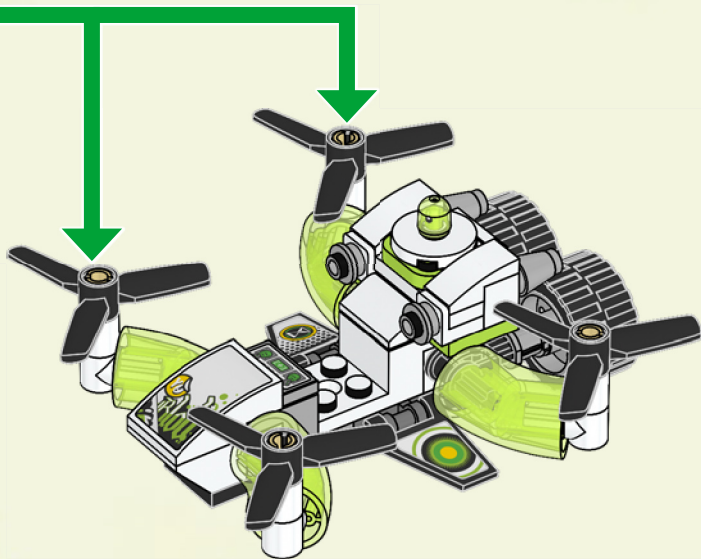



LEGO

DREAMZZZ



71471



71472



71475



71476



71477

A vibrant promotional poster for the LEGO Dreamzzz animated series. The central focus is a group of five LEGO minifigures: a boy in a blue helmet and dark suit holding a sword, a girl with purple hair and a star on her chest, a boy with brown hair and a green cape holding a large pencil, a girl with blonde hair holding a blue blaster, and a white robot with a green head. Behind them is a large, glowing blue and yellow dragon-like creature with a face. The background is a colorful, fantastical landscape with trees, a purple bat-like creature on the left, and a black dragon on the right. The overall scene is set against a bright, glowing sky.

REGARDEZ
LA SÉRIE
EN LIGNE

MIRA
LA SÉRIE
EN INTERNET

LEGO

DREAMZZZ

WATCH
SERIES
ONLINE 



[LEGO.com/DREAMZZZ](https://www.lego.com/DREAMZZZ)



Rebuild
the
world™



1x
6434196



4x
6177114



4x
6345886



2x
6242241



4x
6371416



1x
4547489



1x
6093053



4x
6179606



2x
6034044



1x
6365712



1x
6366391



1x
6156667



1x
6132212



1x
371001



1x
4143254



1x
6053026



4x
6321305



1x
6129995



1x
6434207



1x
6434200



1x
473326



2x
6147050



1x
303426



2x
6363033



2x
4107765



4x
6132299



4x
6360206



2x
4529241



2x
6168647



1x
370626



1x
6440804



2x
6264062



1x
4537936



1x
6328192



2x
6375929



1x
6434257



1x
6434202



1x
370626



1x
6015344



1x
4211414



4x
6109684



2x
6321747



1x
6347992



1x
6360675



1x
4211042



2x
6005331



1x
6443399



1x
4211063



2x
4210660



2x
6274748



4x
6430877



1x
6434204



2x
6274748



4x
6430877



LEGO.com/service

YOU COULD
WIN



Scan this QR code or go to
LEGO.COM/PRODUCTFEEDBACK and give us
your short feedback about this LEGO® set
for a chance to win a cool LEGO prize.

Terms and Conditions apply*

EN: YOU COULD WIN. Terms and Conditions apply* **DE: Du könntest GEWINNEN.** Es gelten die Teilnahmebedingungen* **FR: Tu pourrais GAGNER.** Des conditions s'appliquent* **IT: Potresti VINCERE tu.** Termini e condizioni sono applicabili* **ES: Puedes GANAR.** Aplican términos y condiciones* **PT: Poderá GANHAR.** Aplicam-se termos e condições* **ZH: 轻松获奖. 条款和条件适用*** **PL: Szansa na WYGRANĄ.** Obowiązują warunki korzystania* **CS: Máte šanci VYHRÁT.** Platí všeobecné smluvní podmínky* **SK: Máte šancu VYHRÁT.** Platia všeobecné zmluvné podmienky* **HU: TE IS NYERHETSZ.** Felhasználási feltételek érvényesek* **RO: Ai putea CÂȘTIGA.** Se aplică termeni și condiții* **BG: Можете да СПЕЧЕЛИТЕ.** Има определени правила и условия* **LV: Tu vari LAIMĒT.** Ir spēkā noteikumi un nosacījumi.* **ET: Sul on võimalus VÕITA.** Kehtivad tingimused* **LT: Jūs galite LAIMĖTI.** Taikomos sąlygos*

*[LEGO.com/productfeedback-terms](https://www.lego.com/productfeedback-terms)

LEGO, the LEGO logo, DREAMZzz and the DREAMZzz logo are trademarks of the/
sont des marques de commerce du/son marcas registradas de LEGO Group.

©2024 The LEGO Group.

All rights reserved/Tous droits réservés/Todos los derechos reservados.

6494352